

1

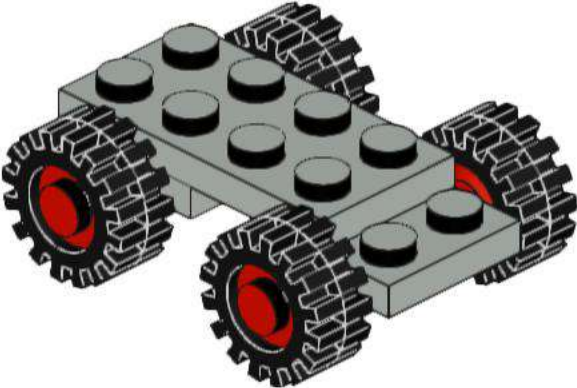

# 2

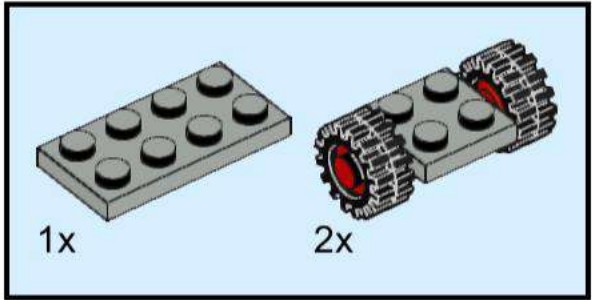
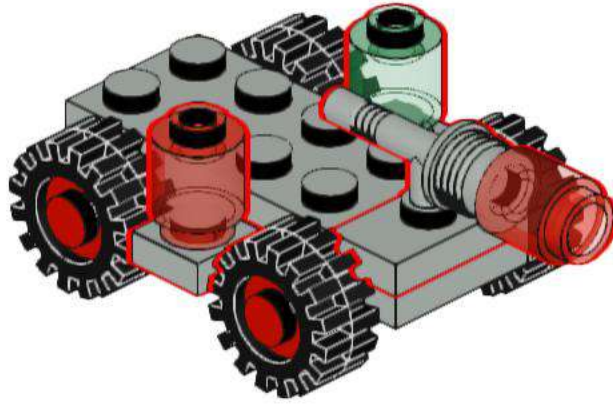
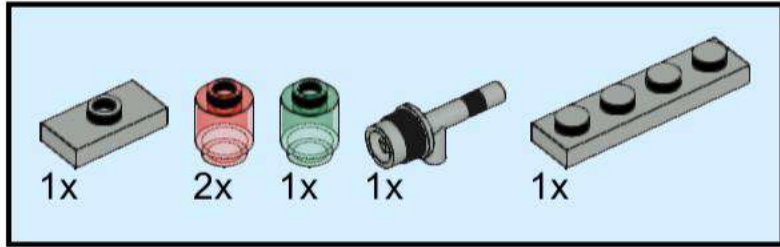

3

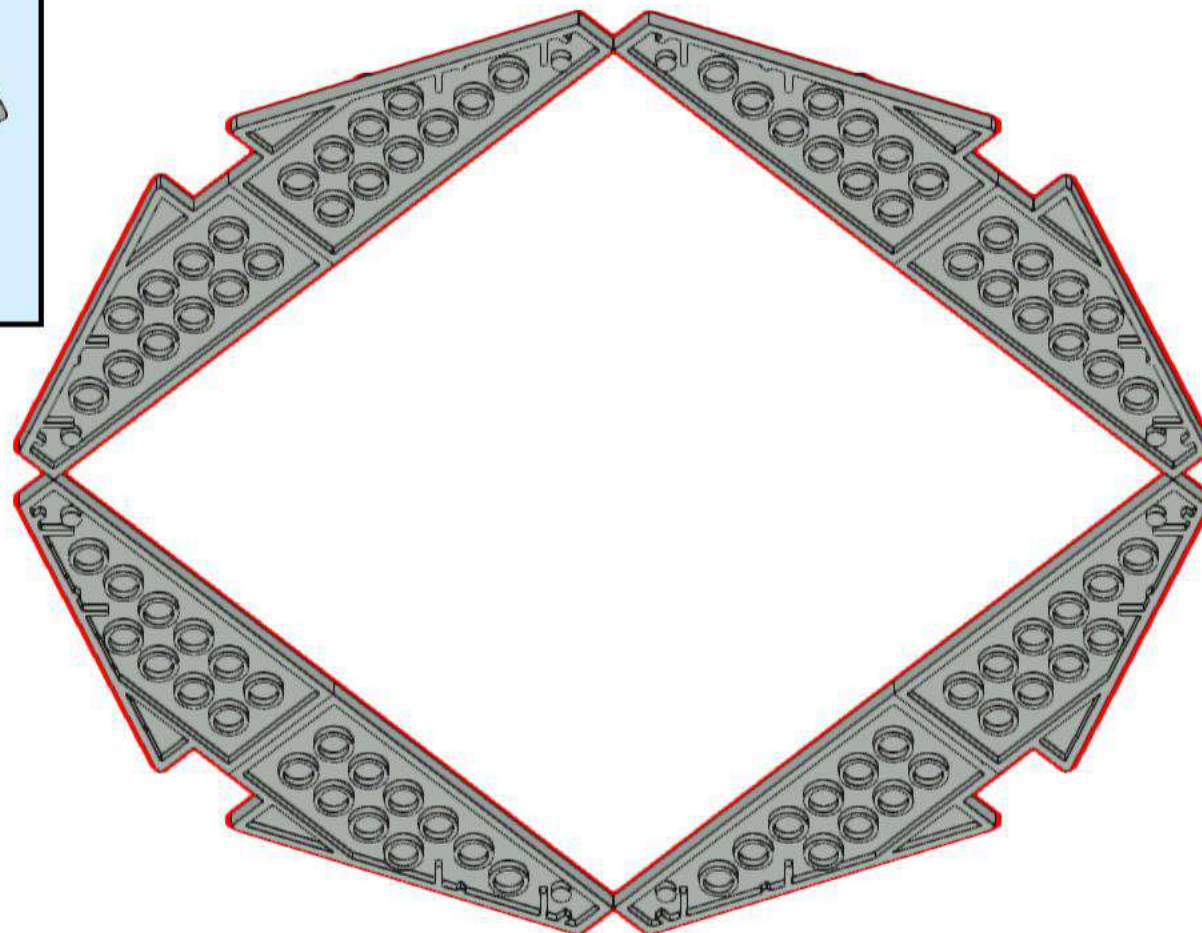
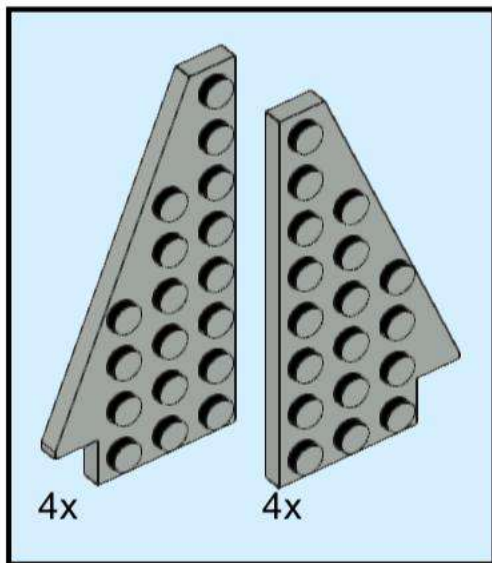

# 4

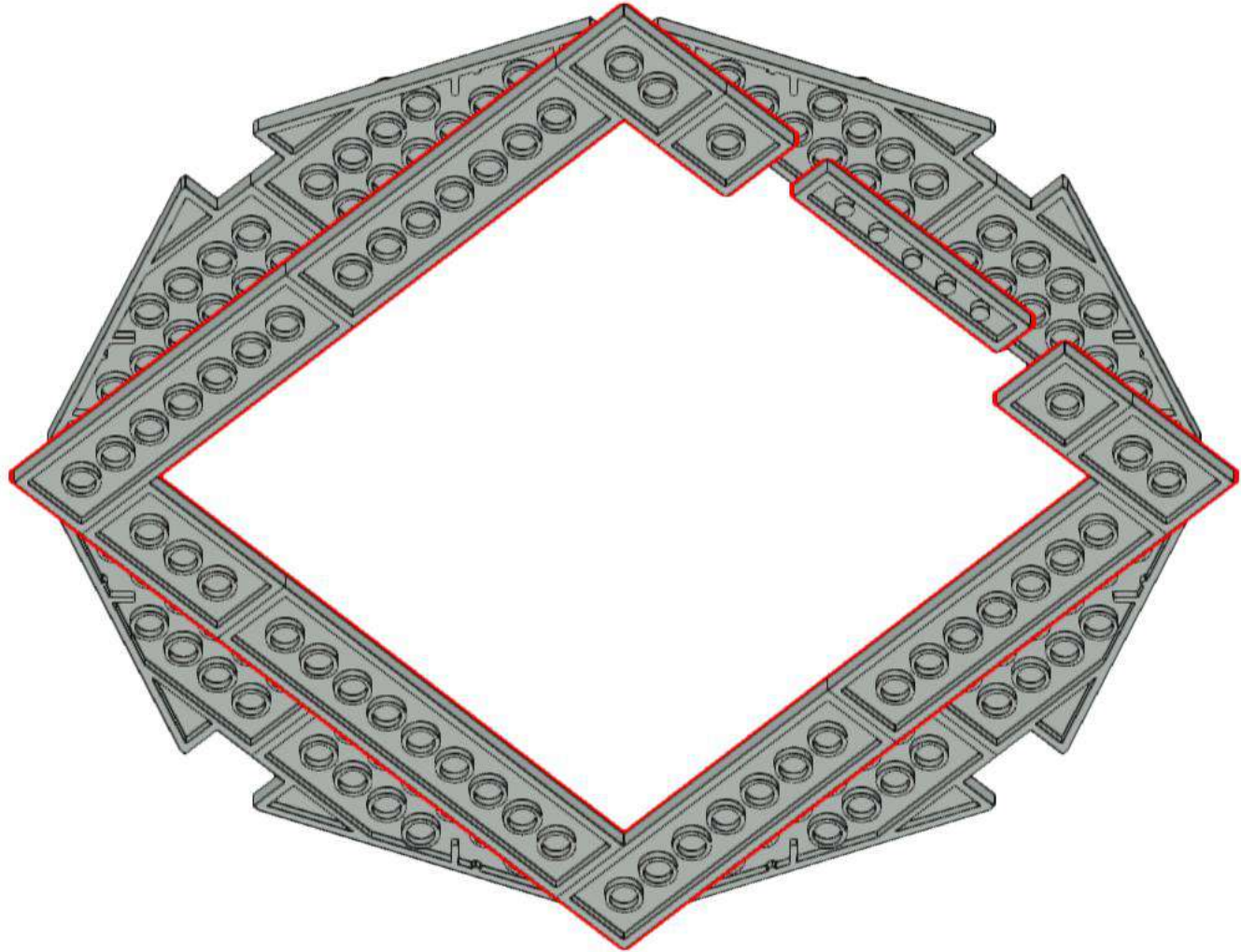
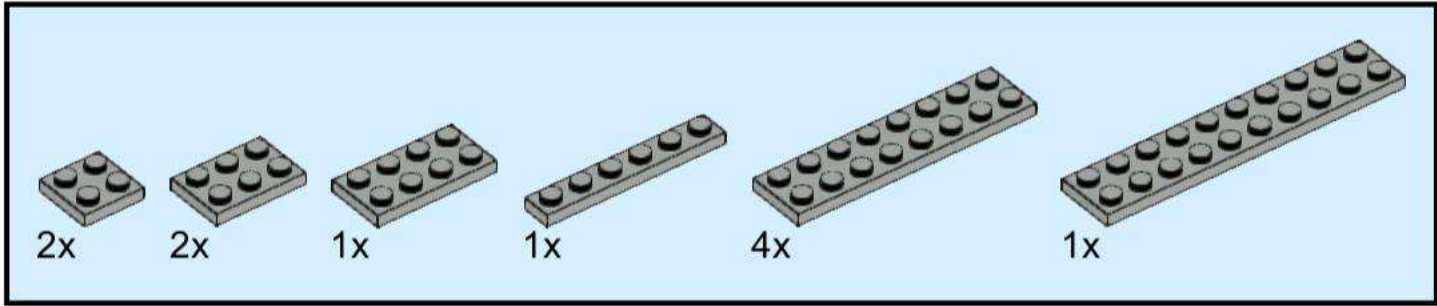

5

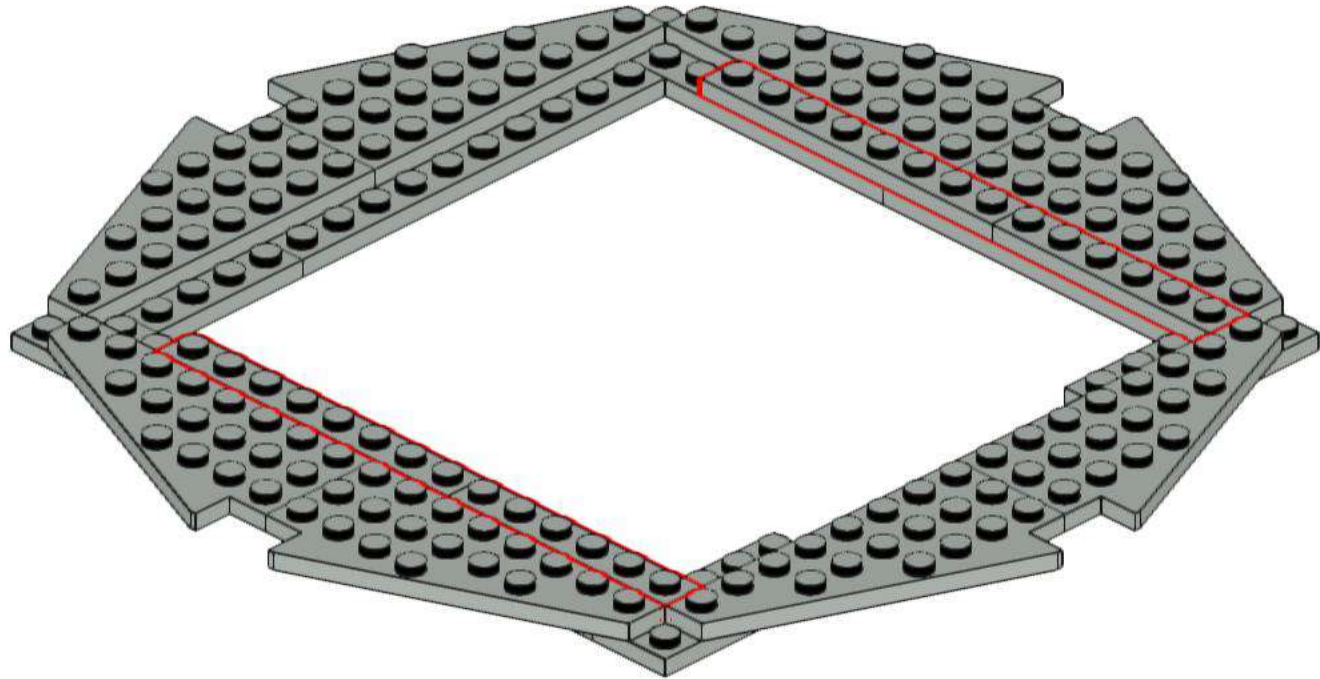
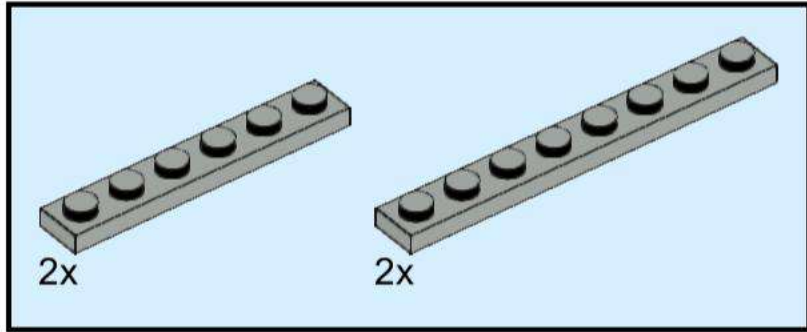

6

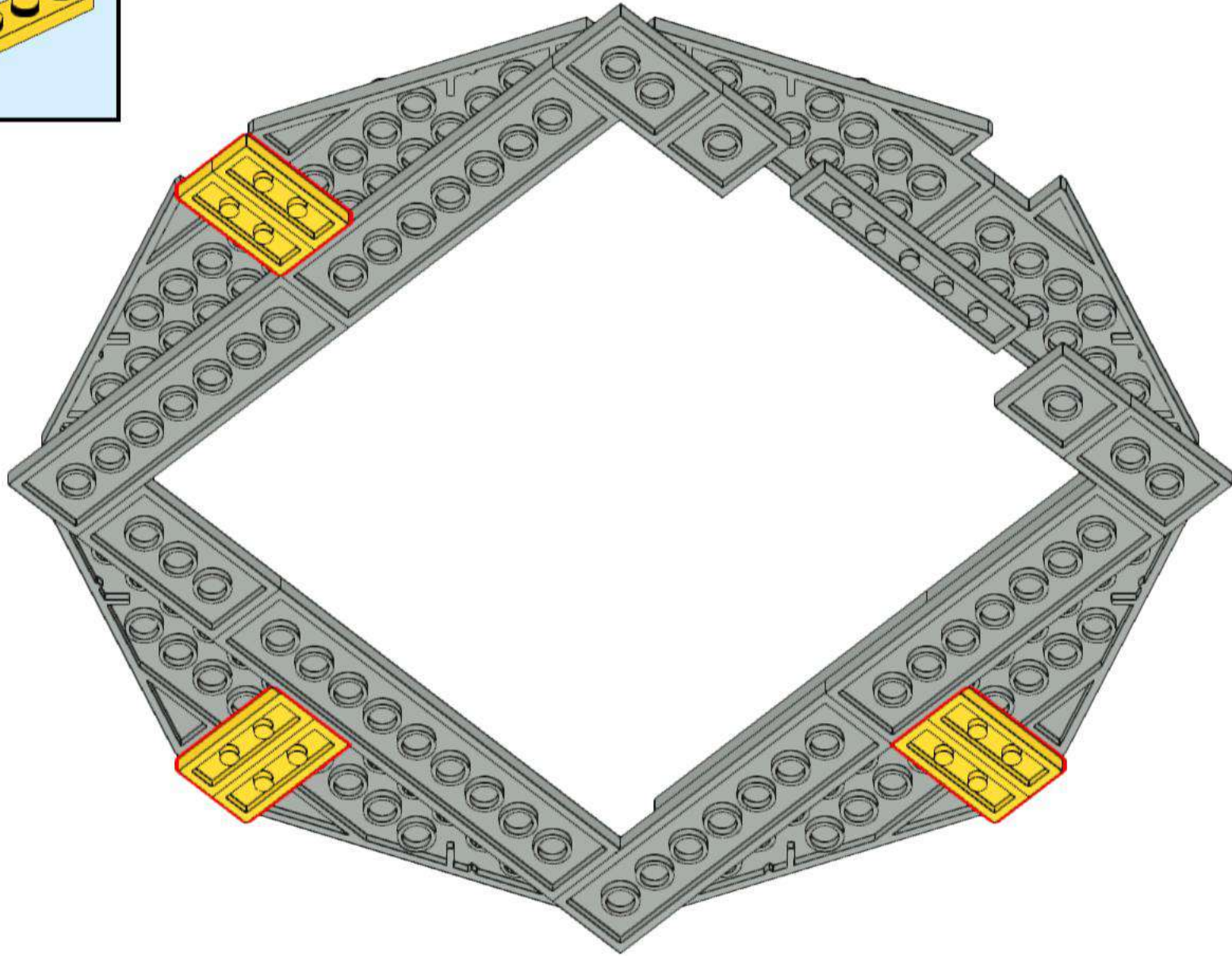
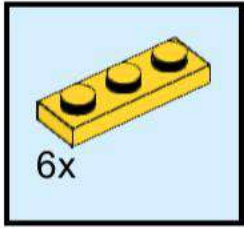

7

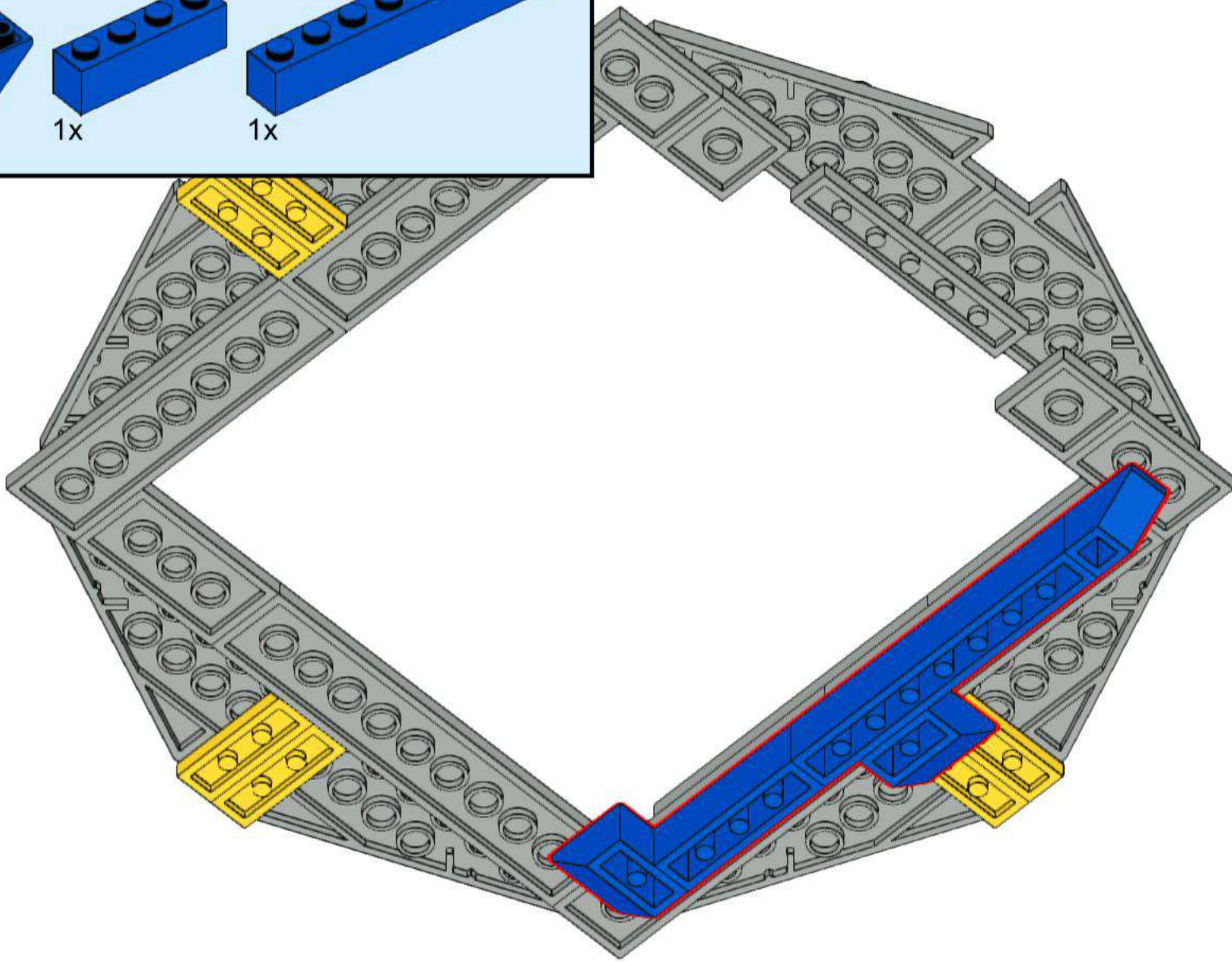
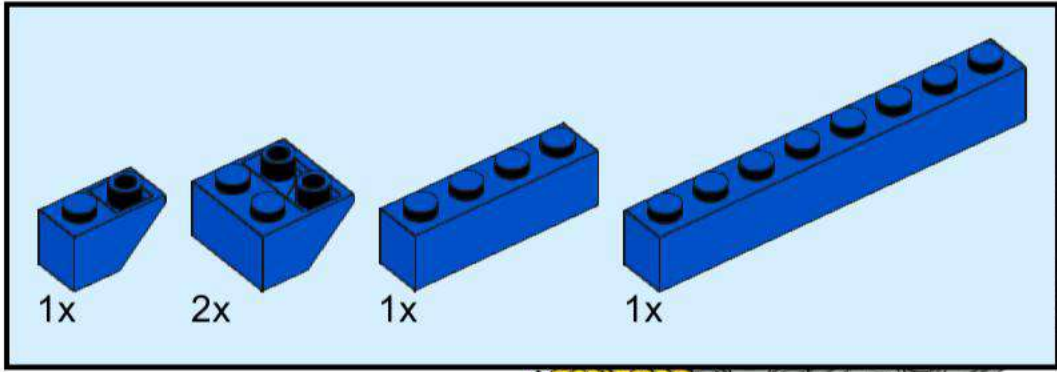

8

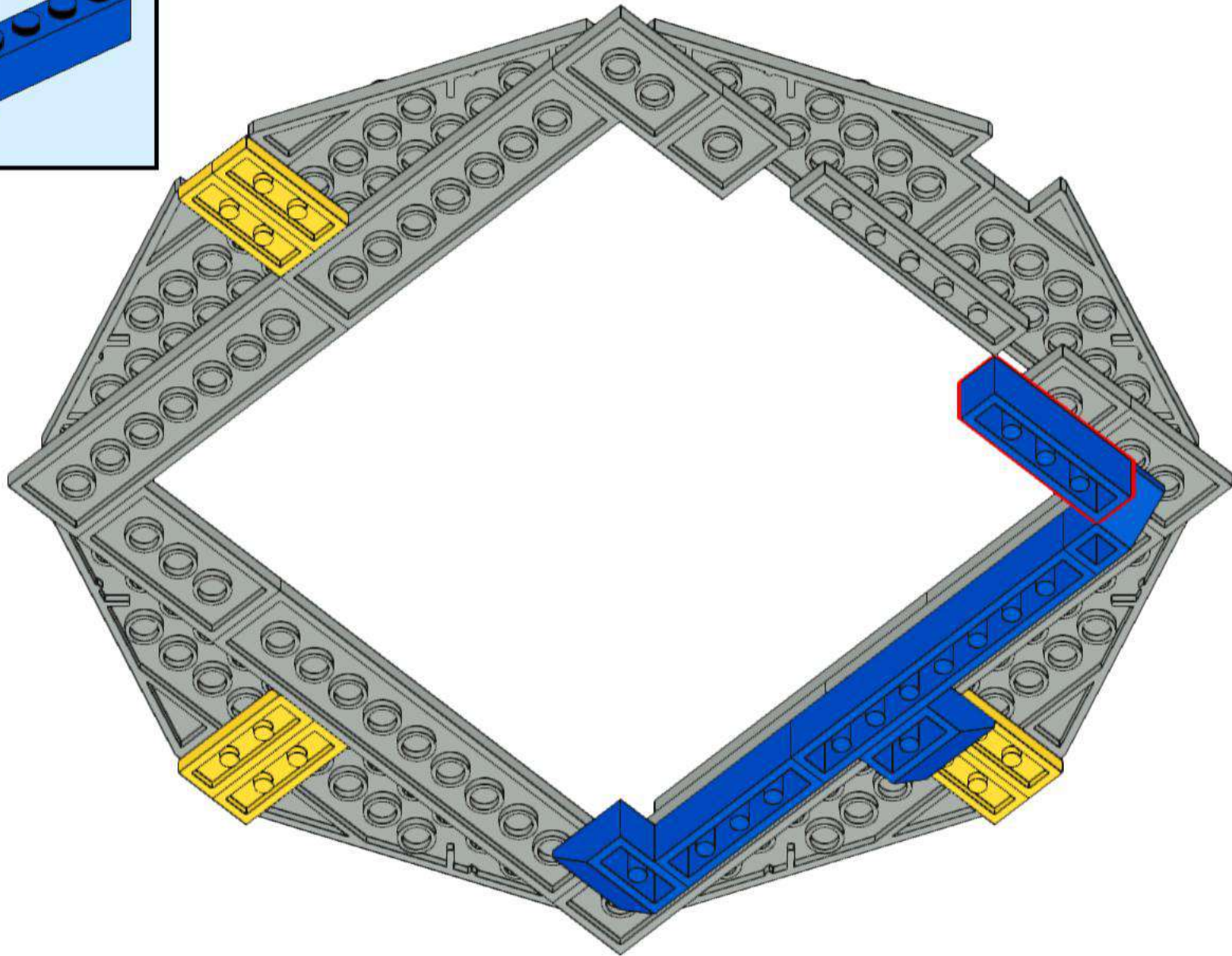
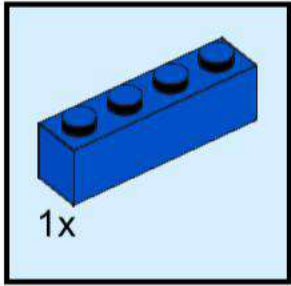



9

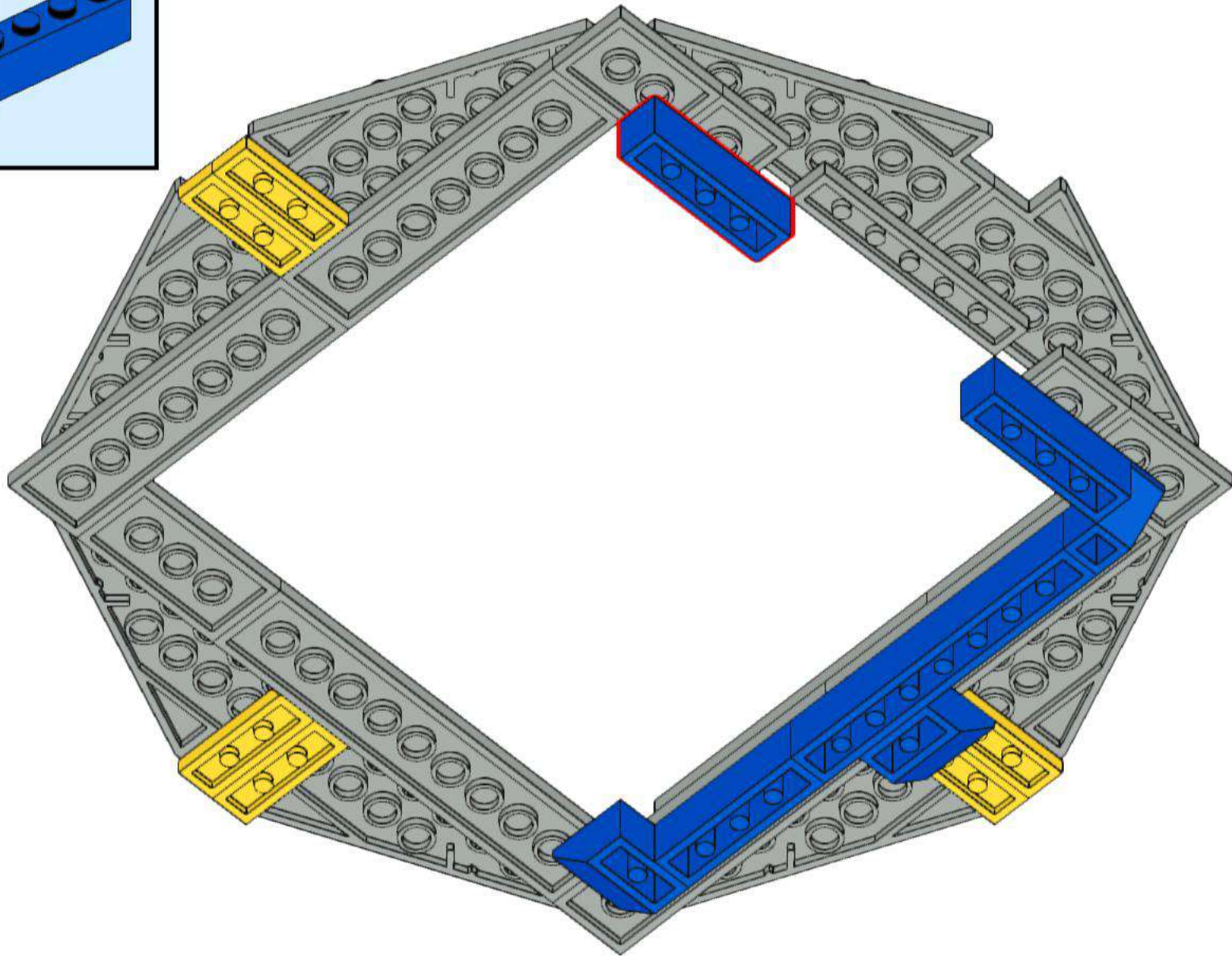
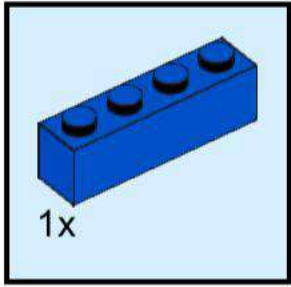

# 10

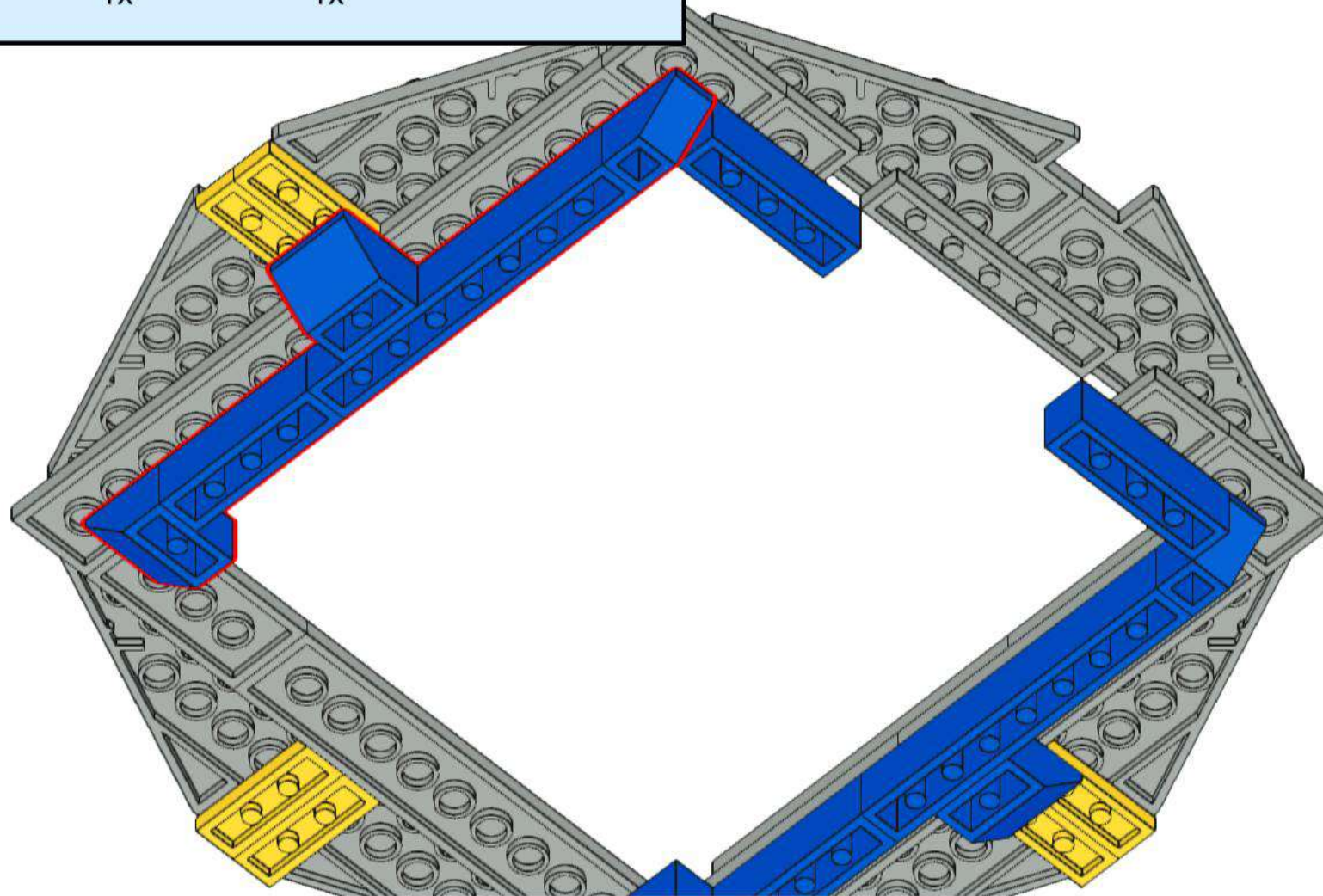
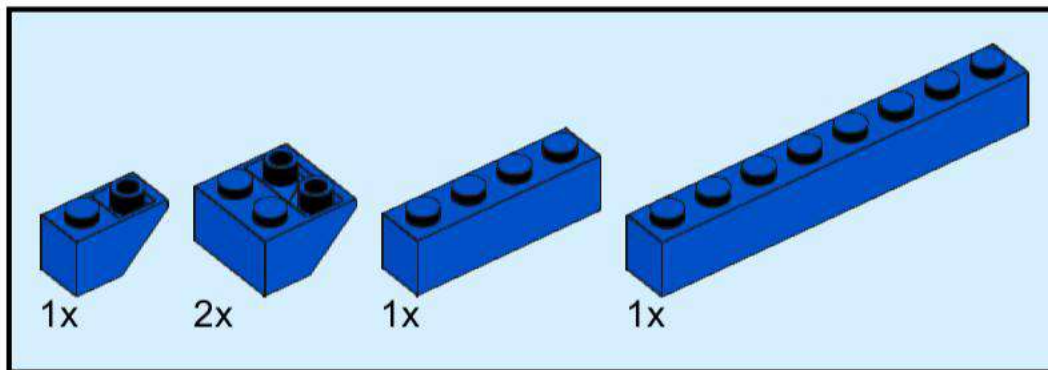

# 11

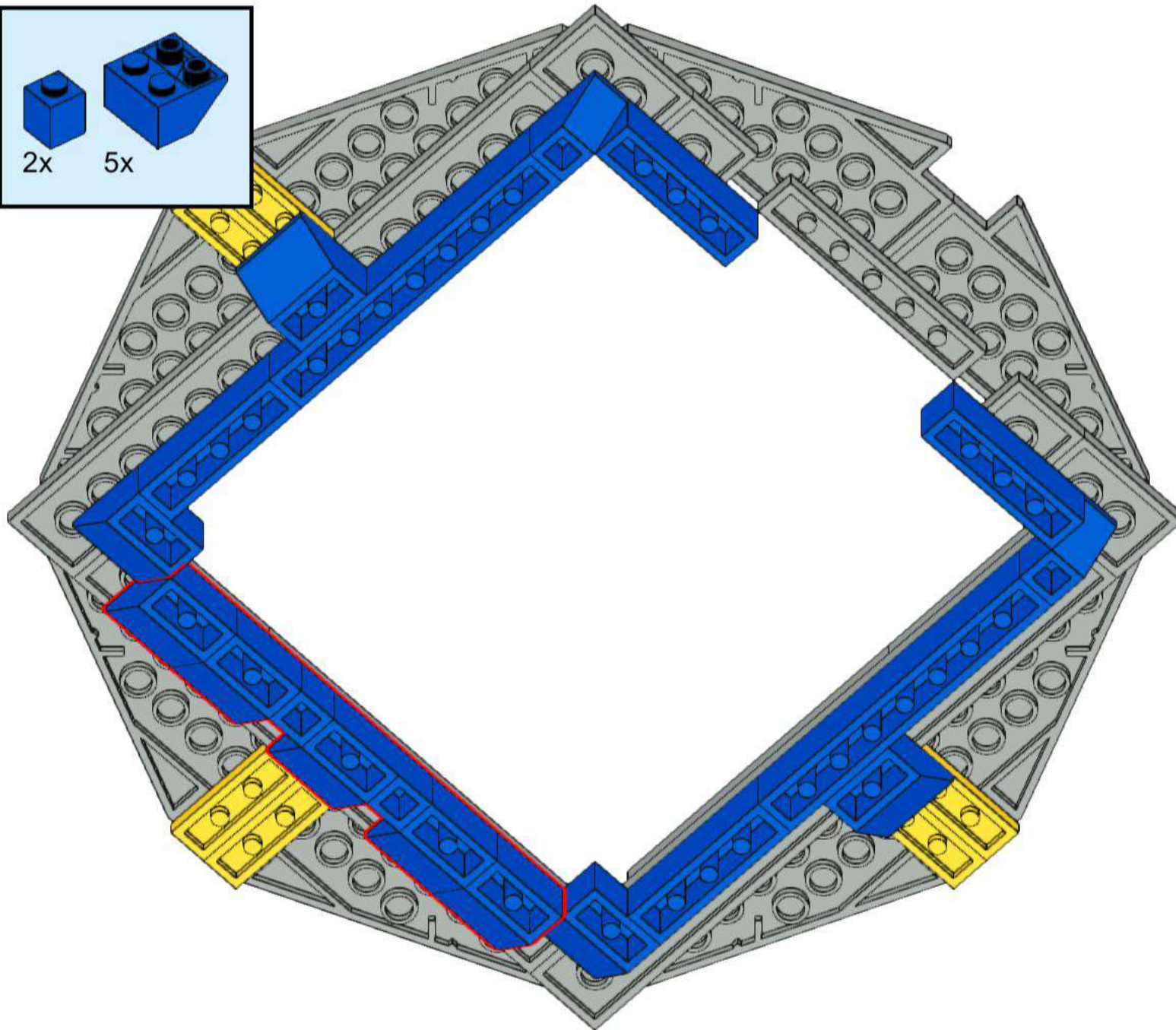
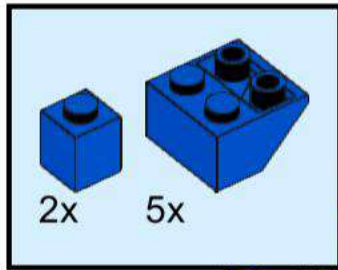

# 12

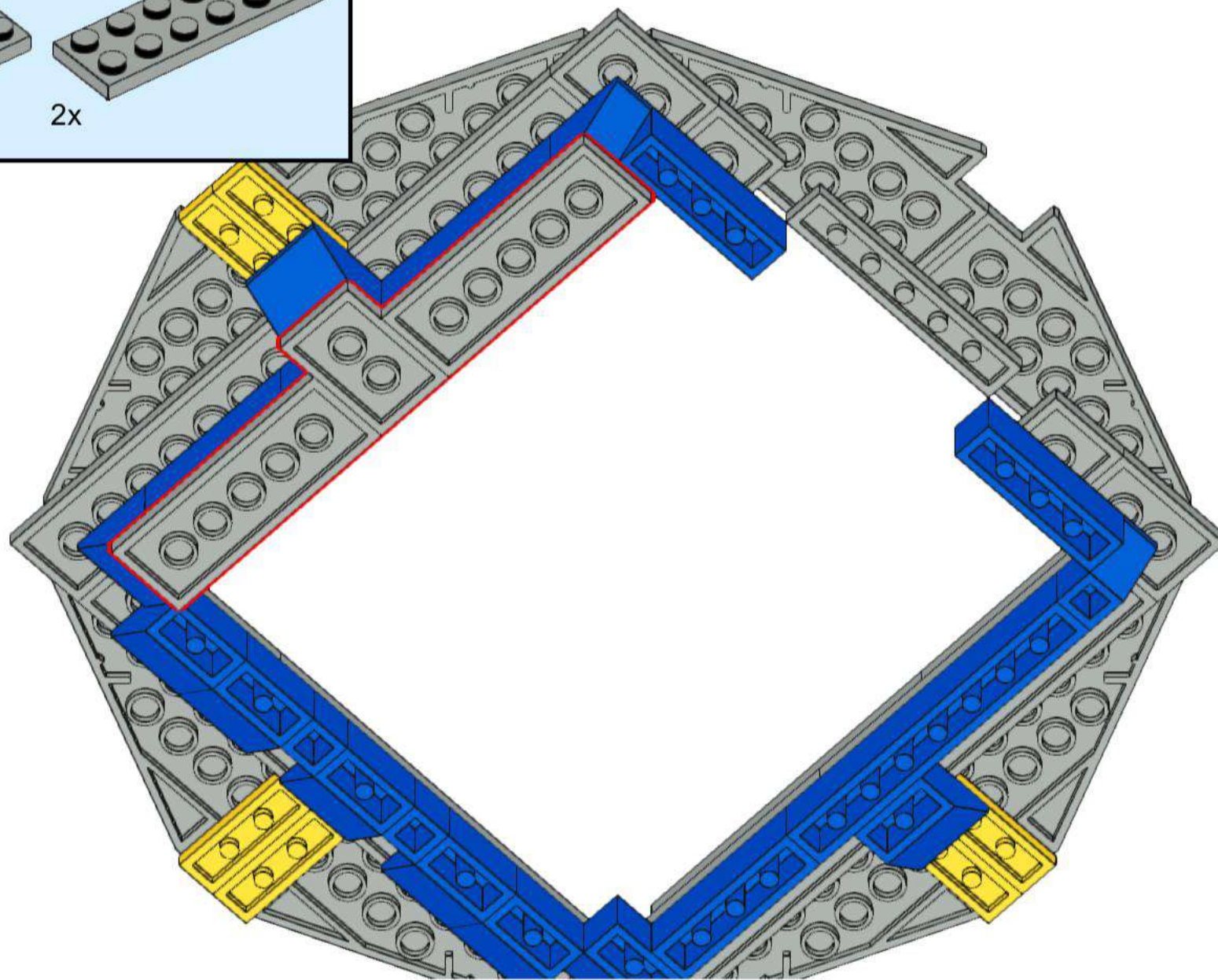
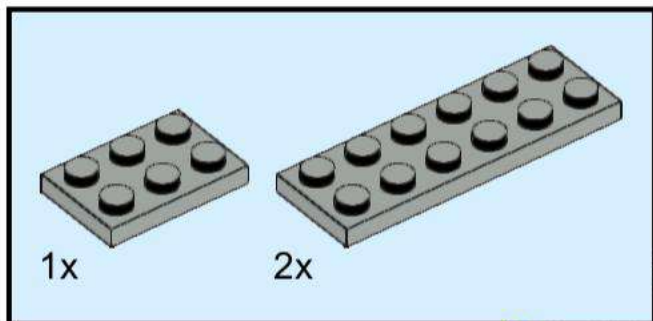

# 13

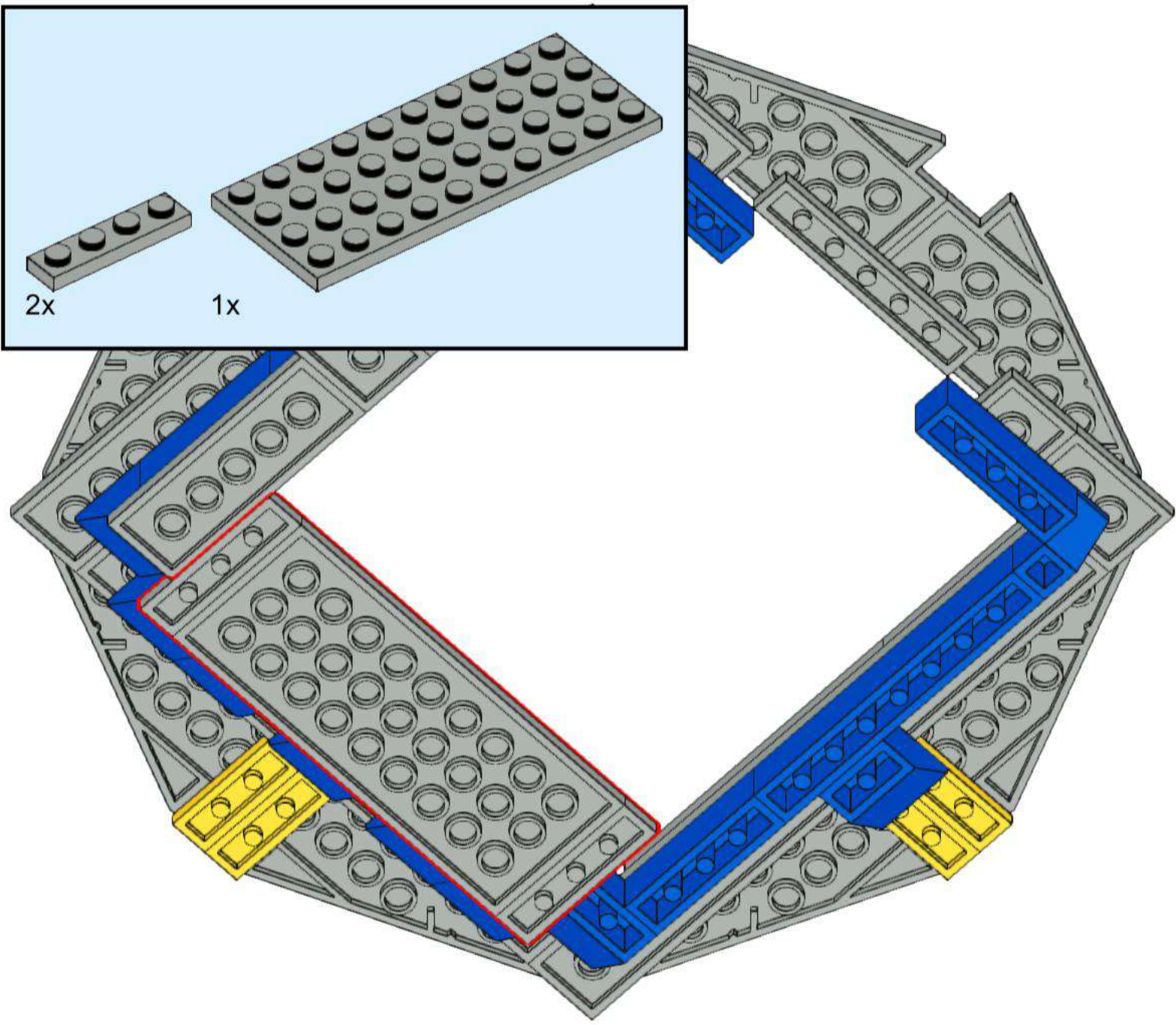
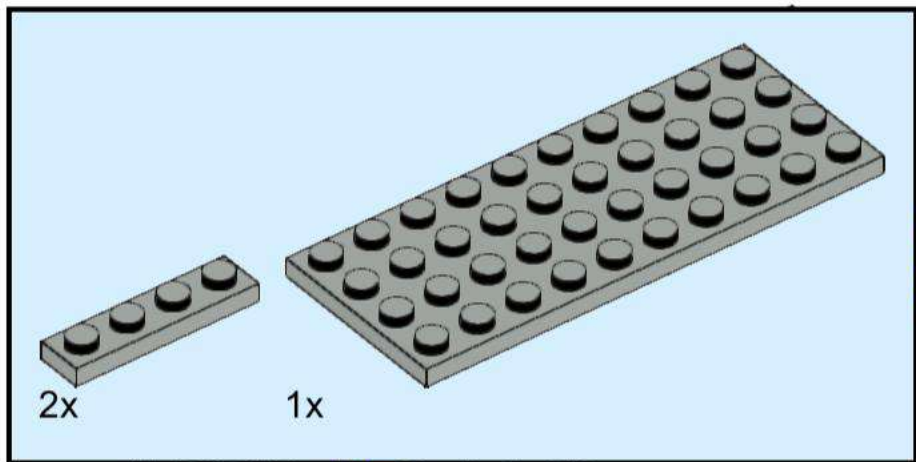

# 14

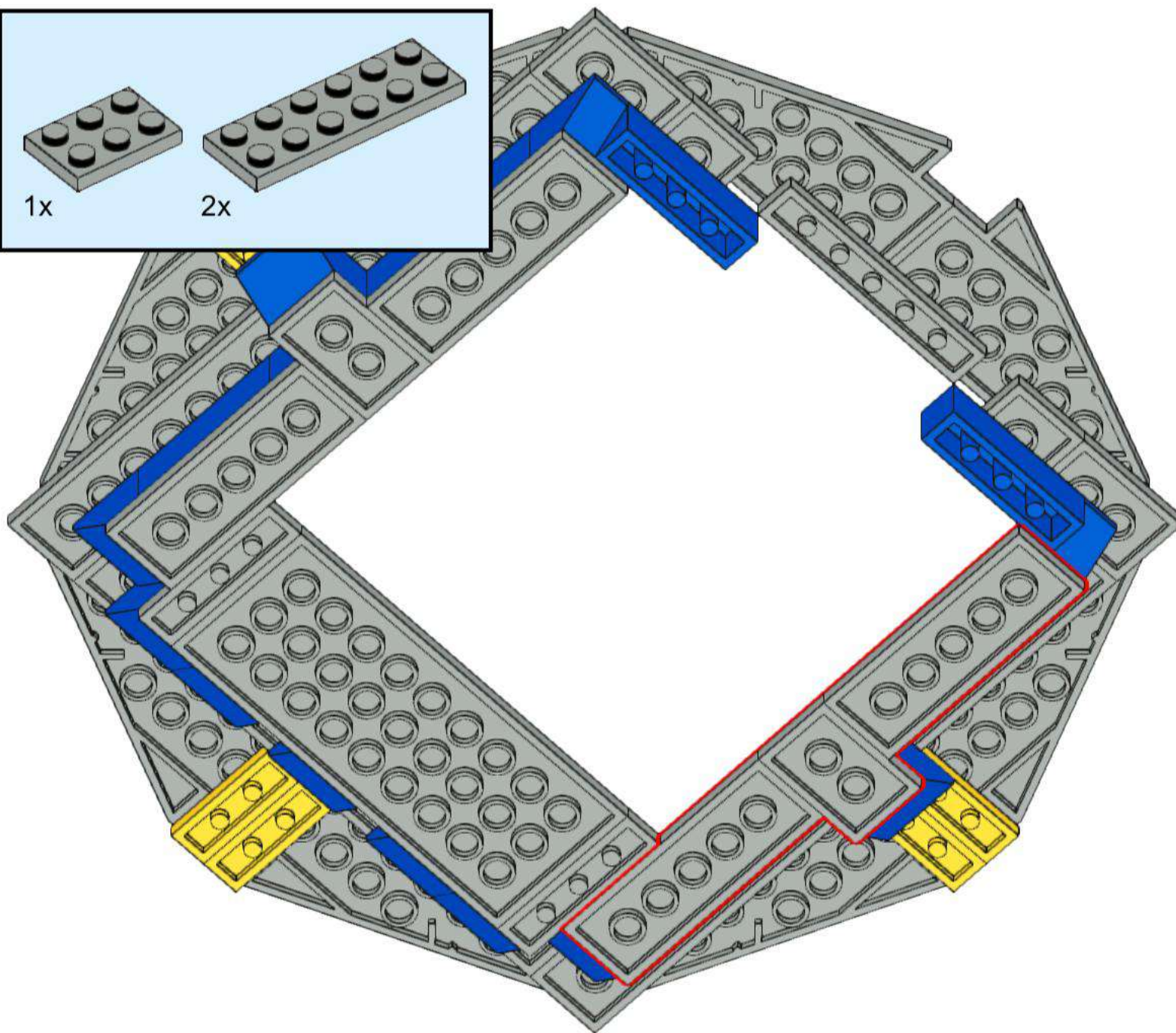
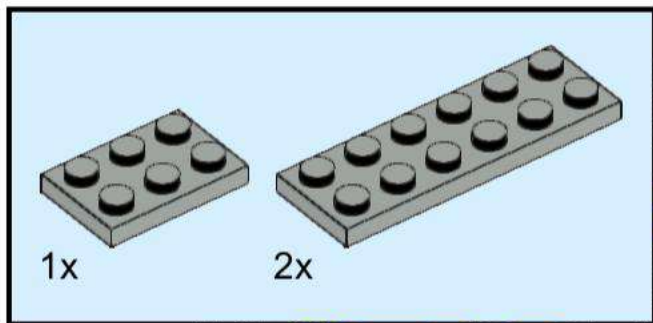



# 16

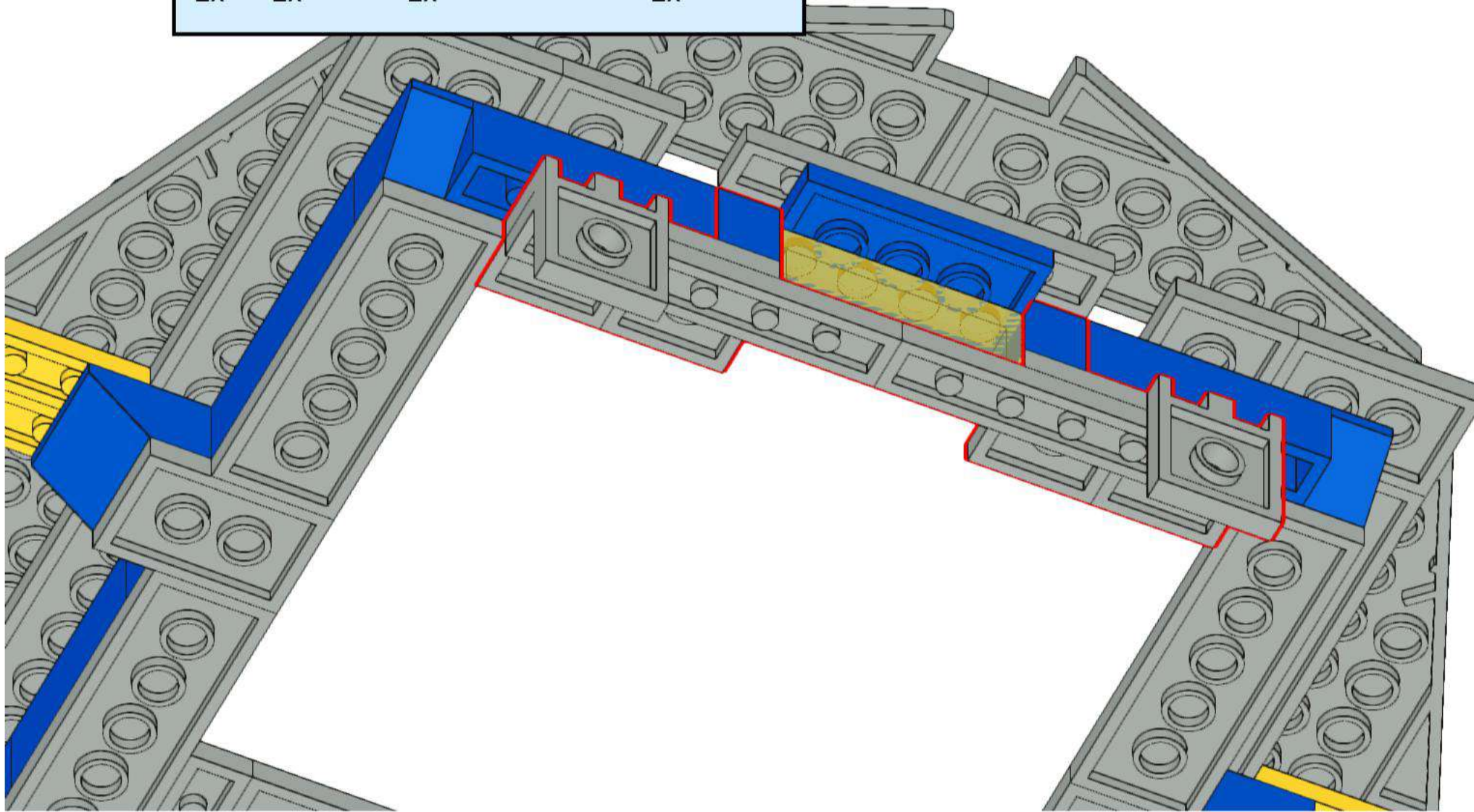
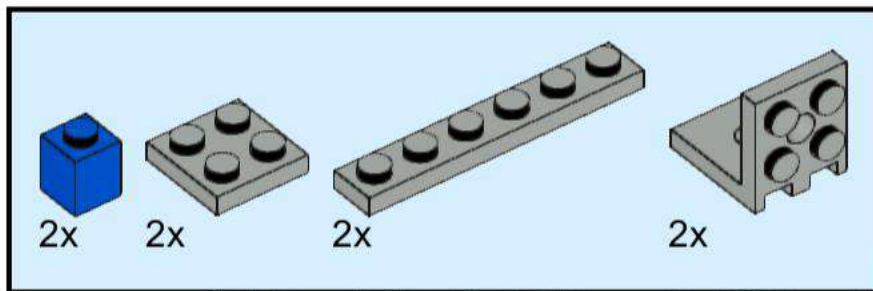



# 17

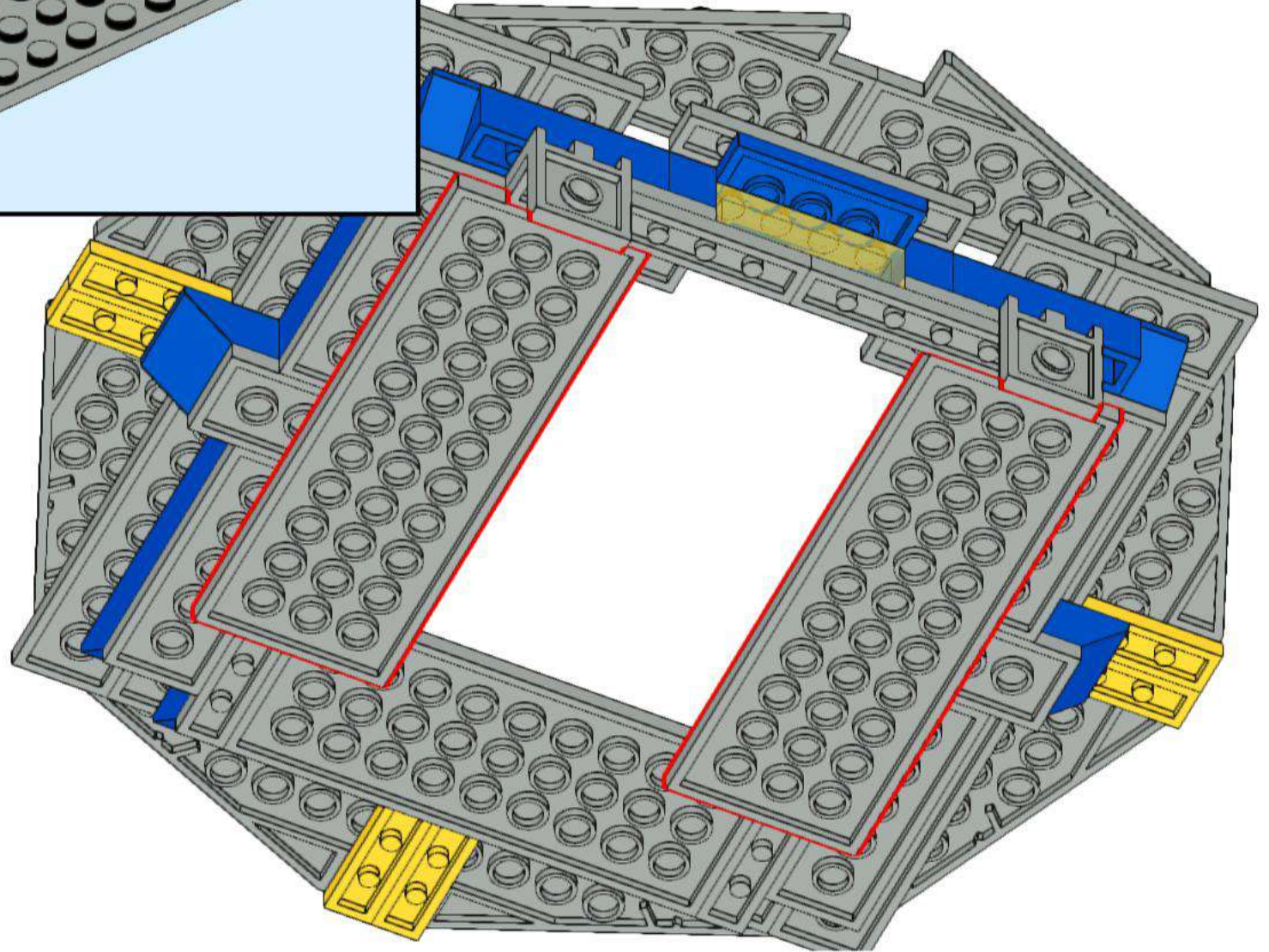
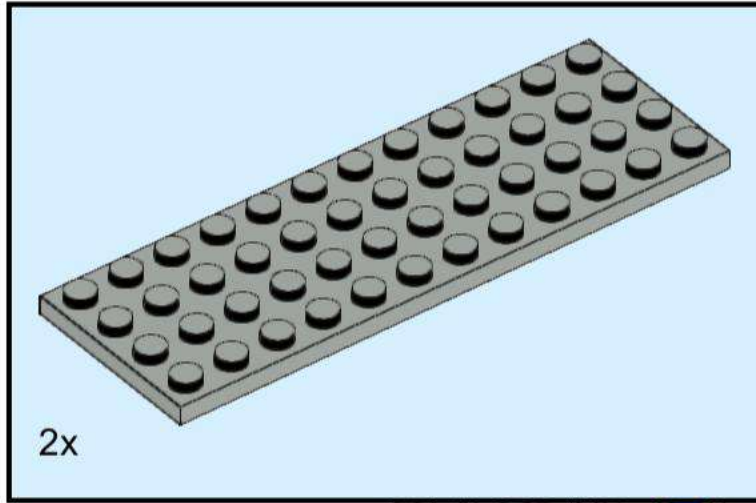

# 18

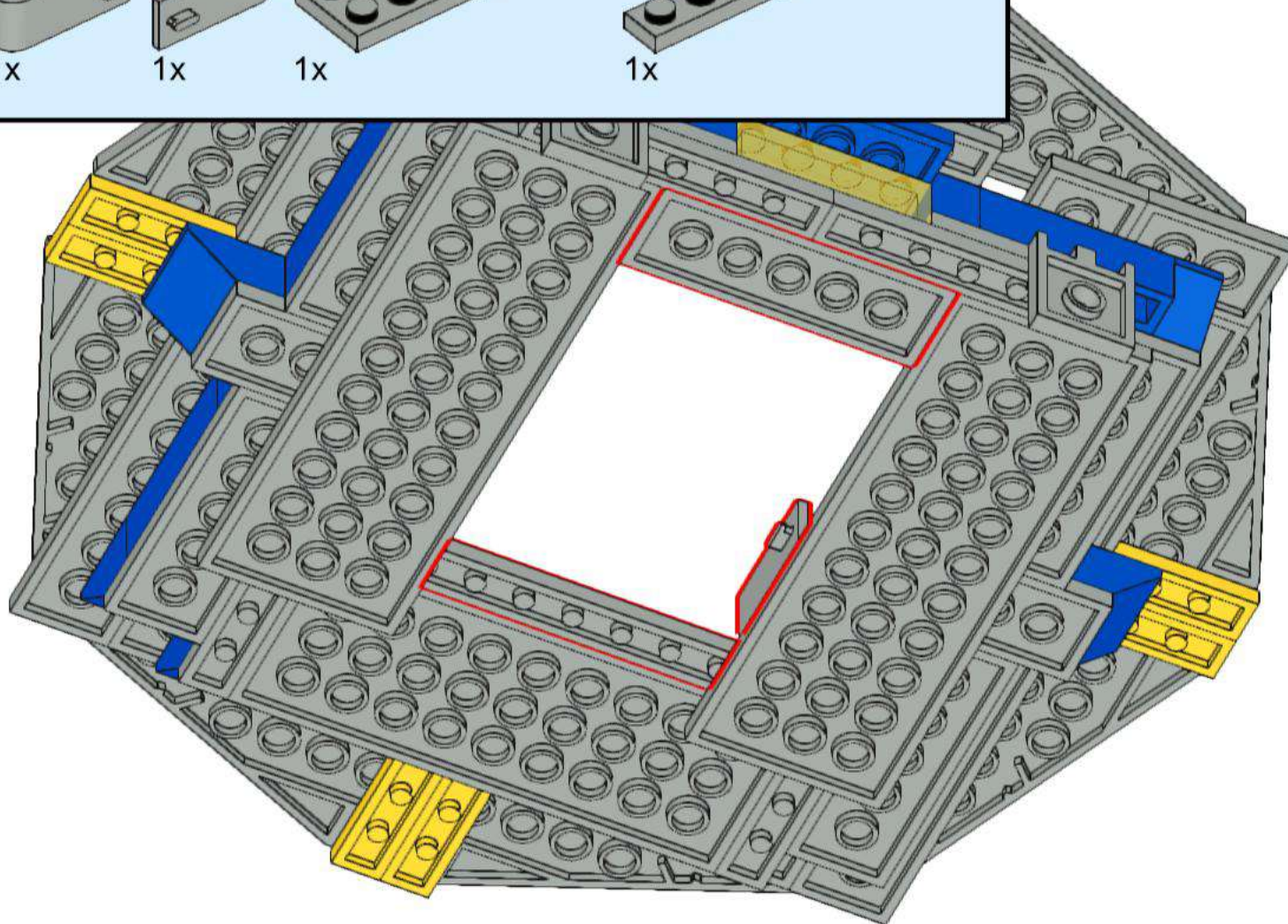
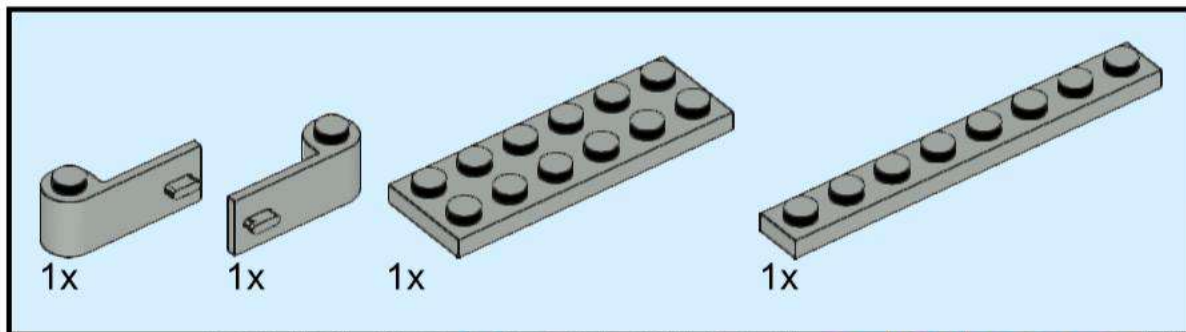

# 19

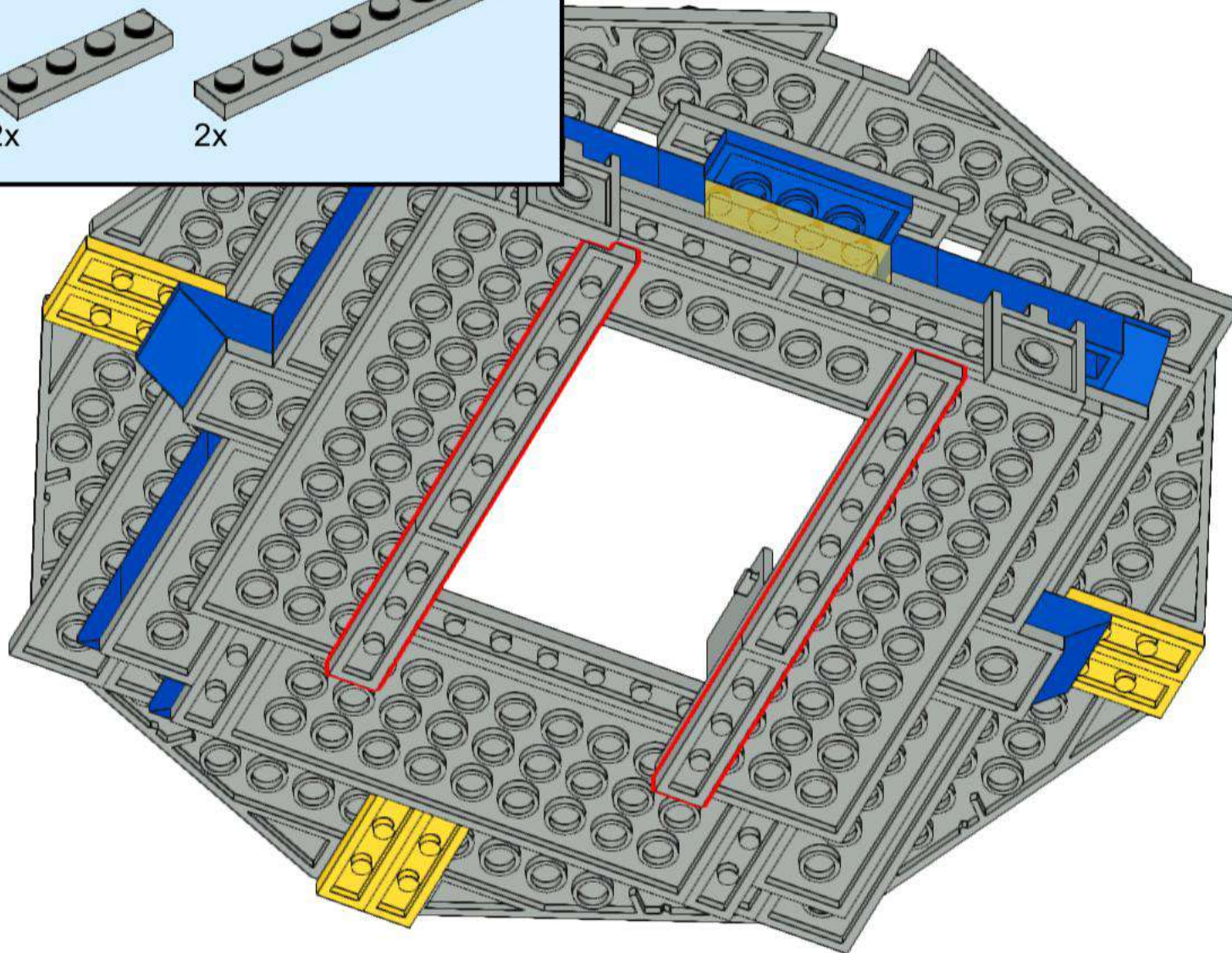
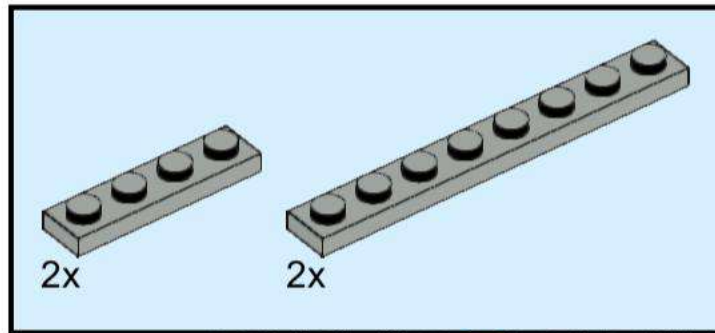

# 20

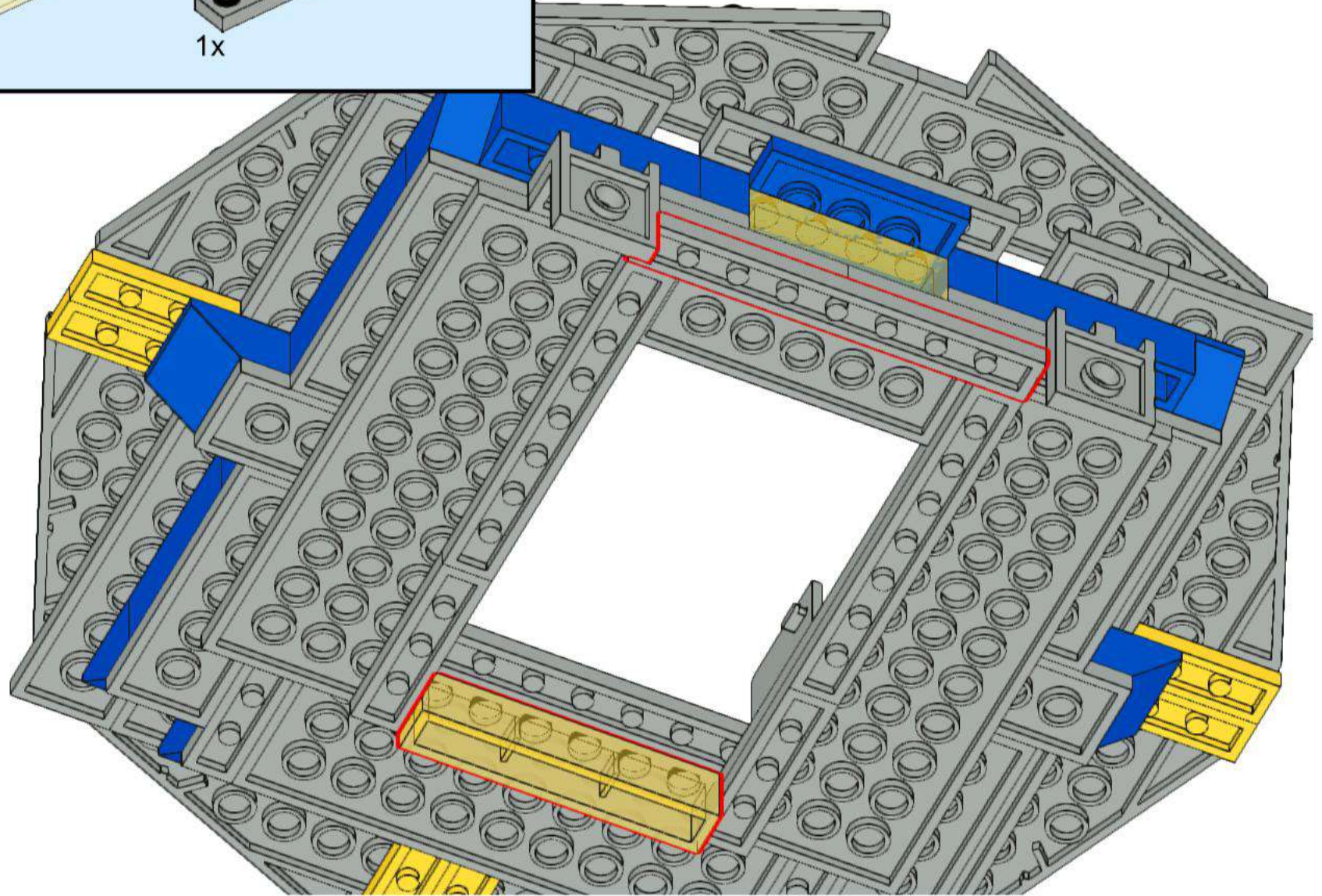
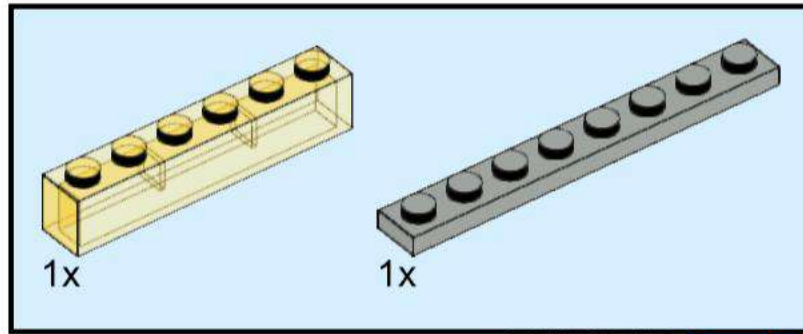

# 21

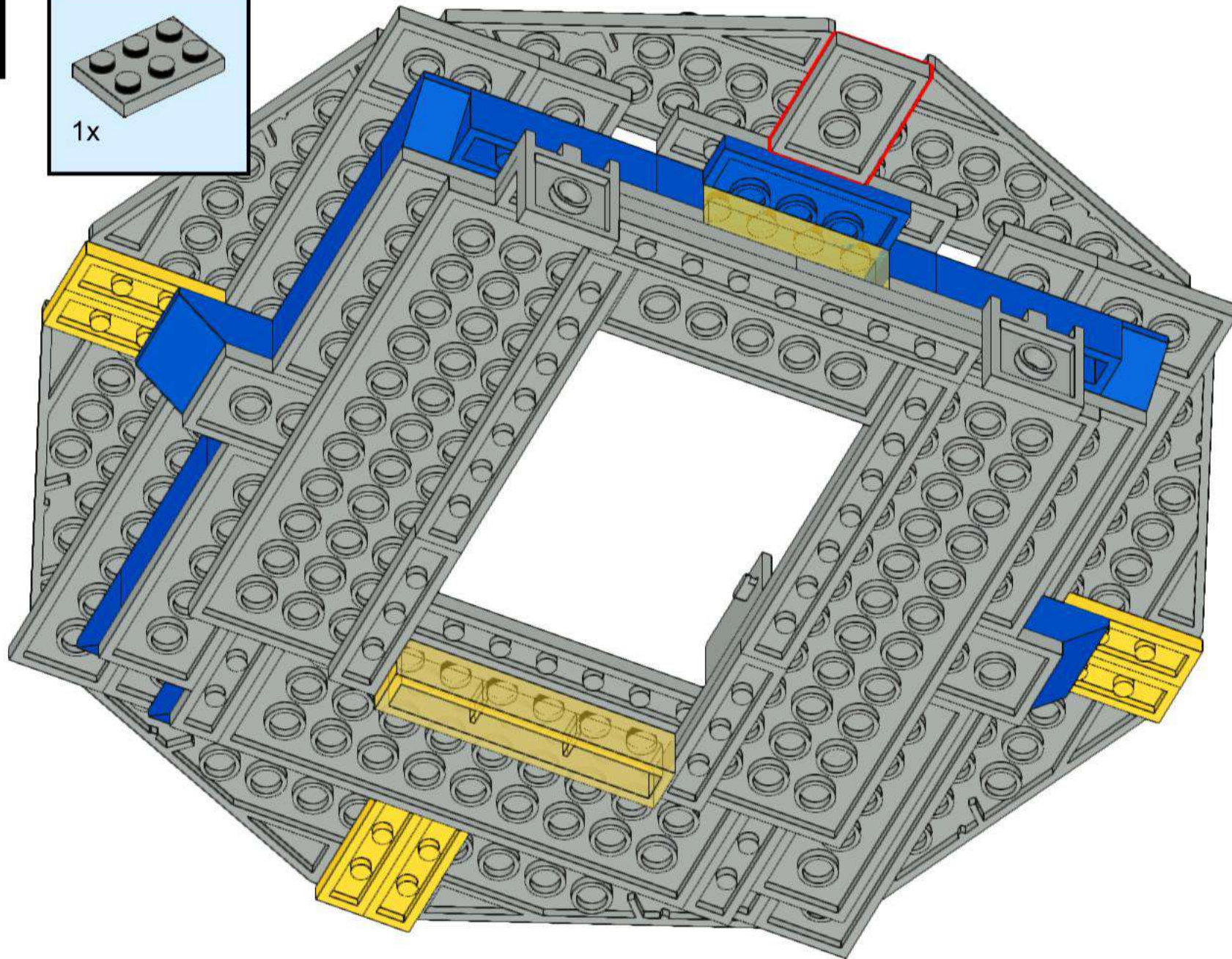
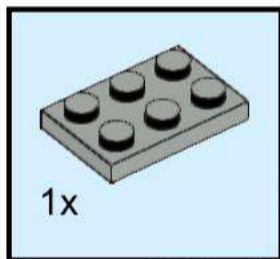

# 22

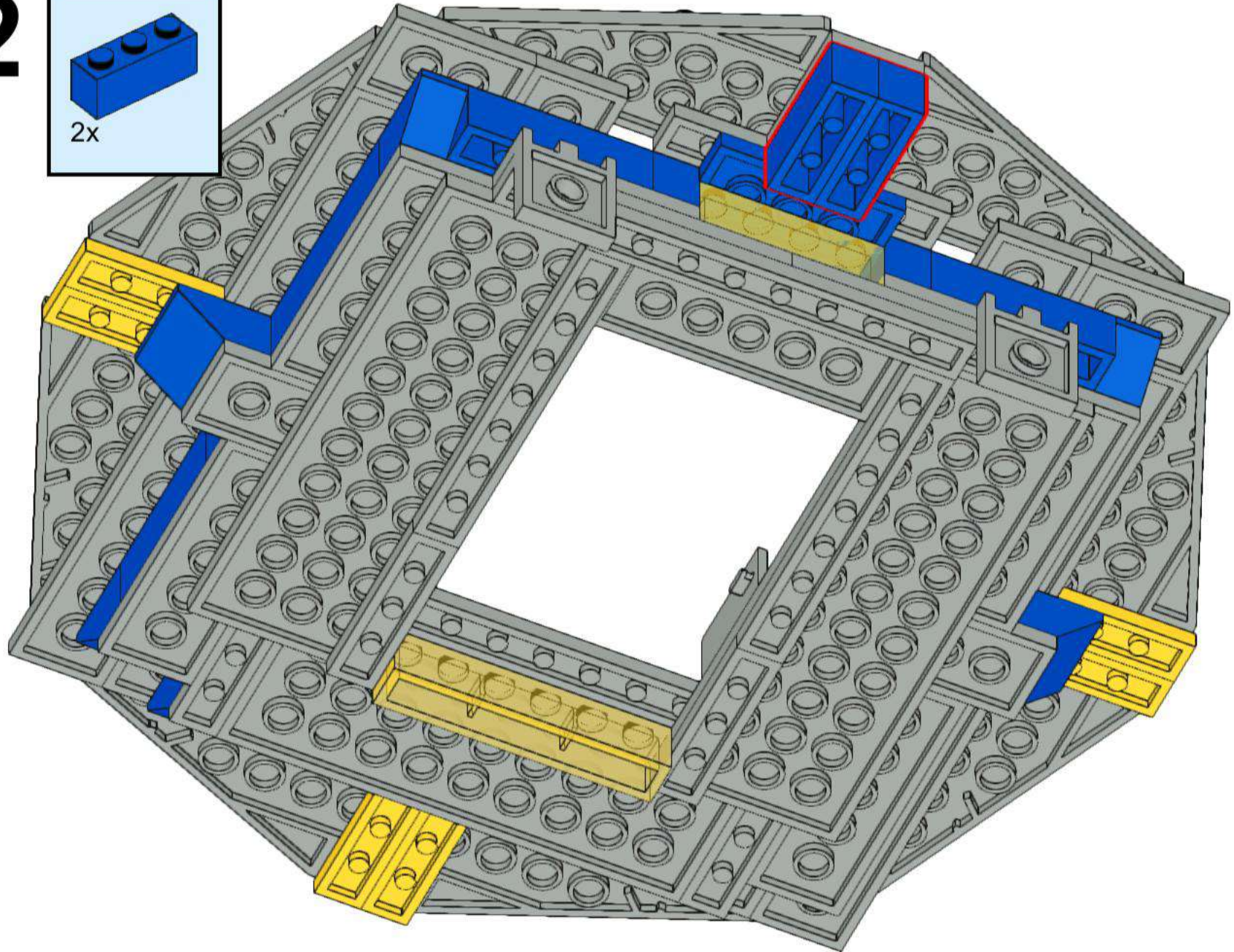
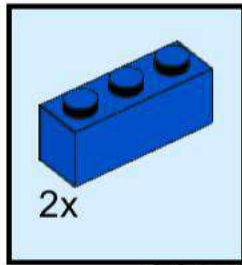

# 23

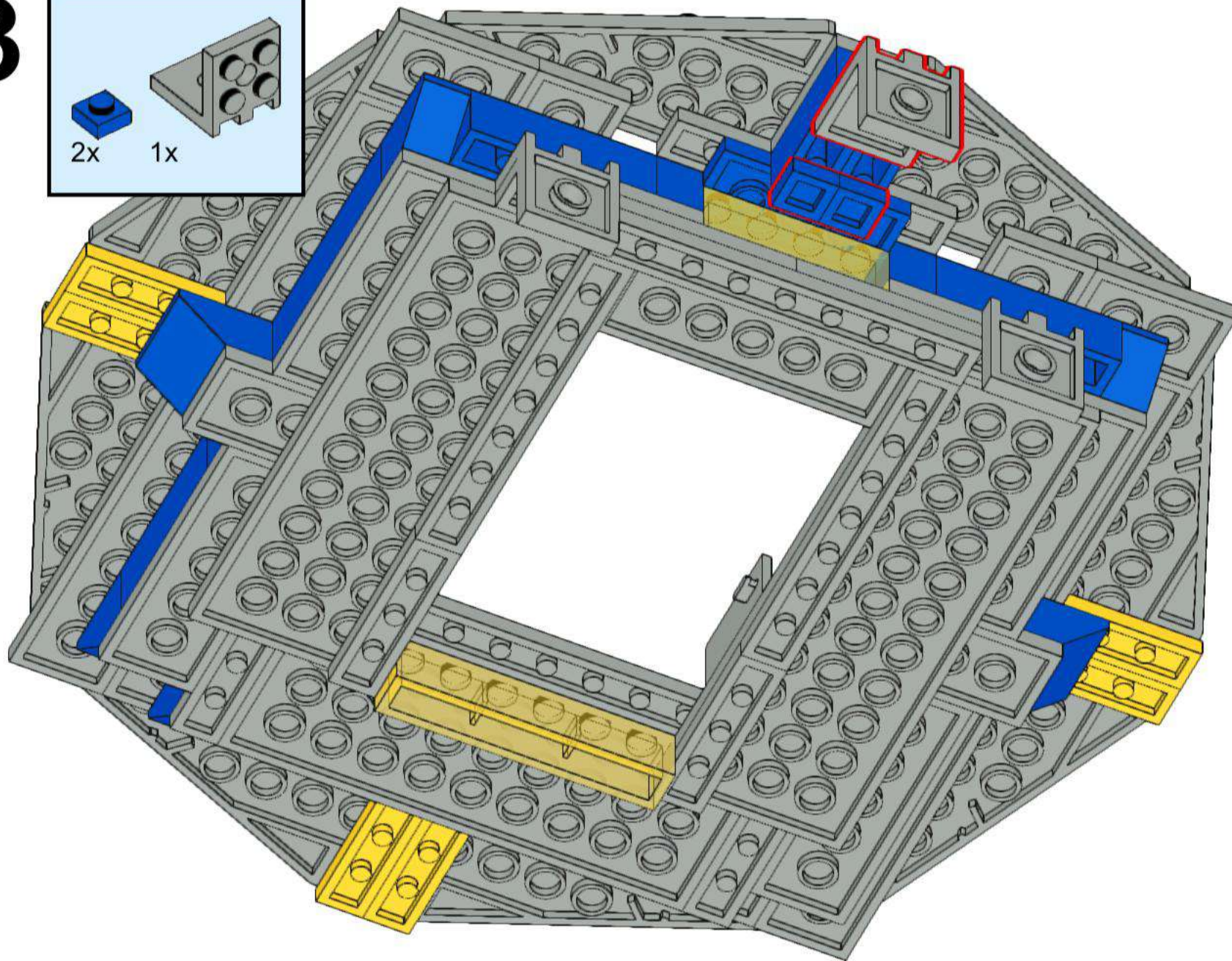
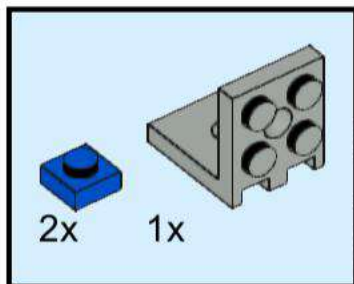

# 24

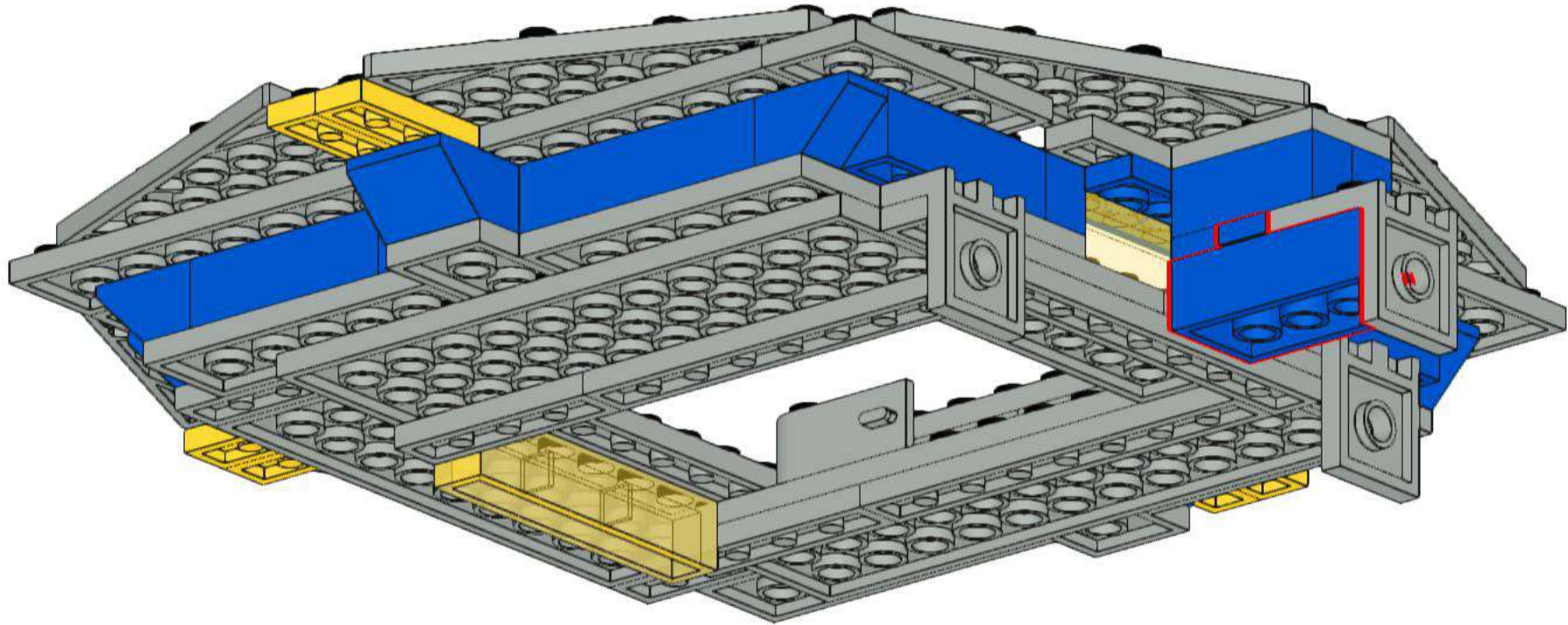
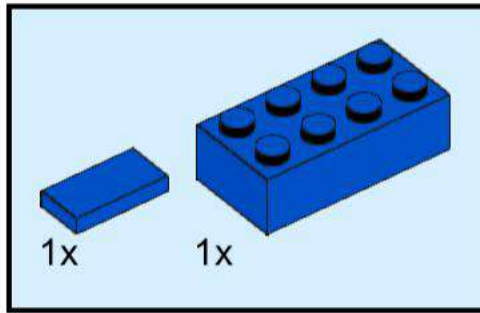



# 25

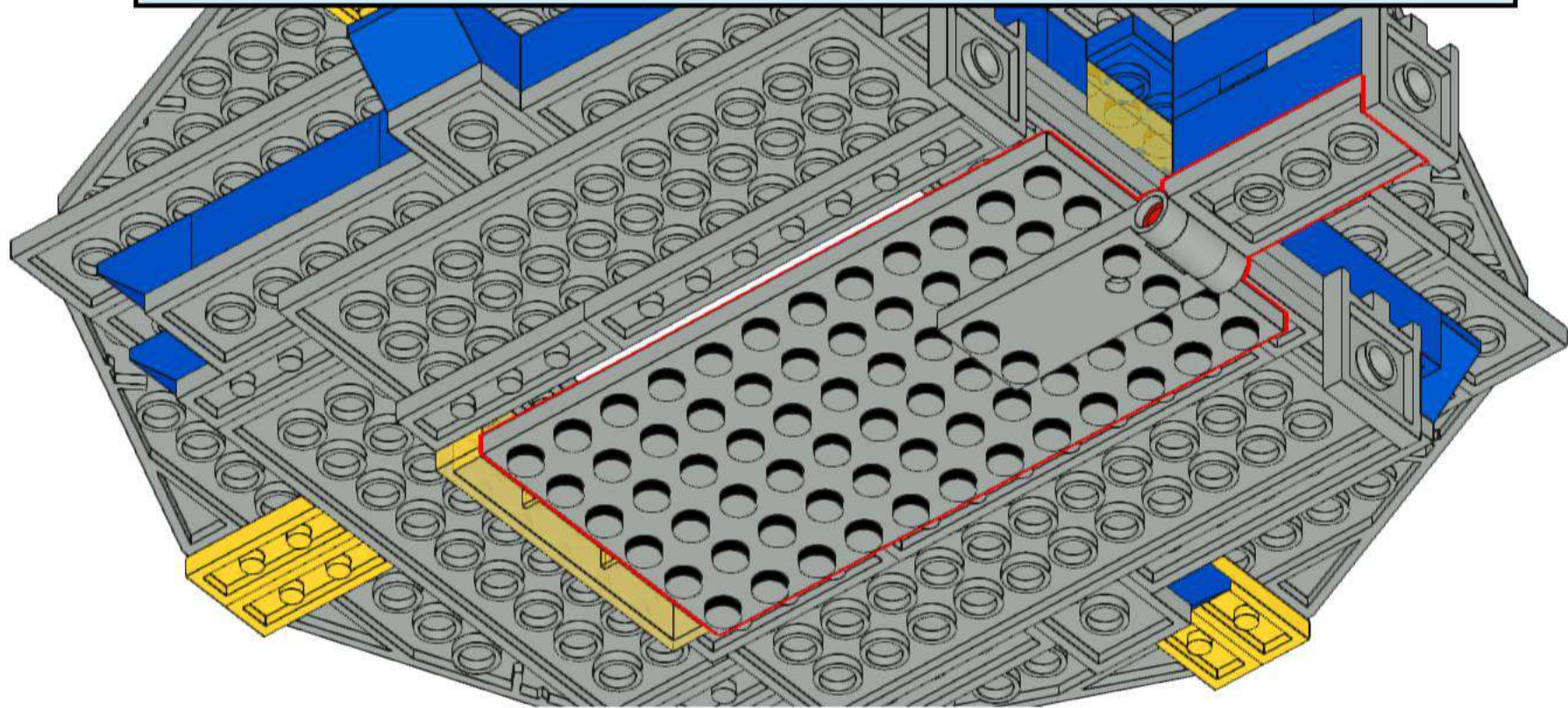
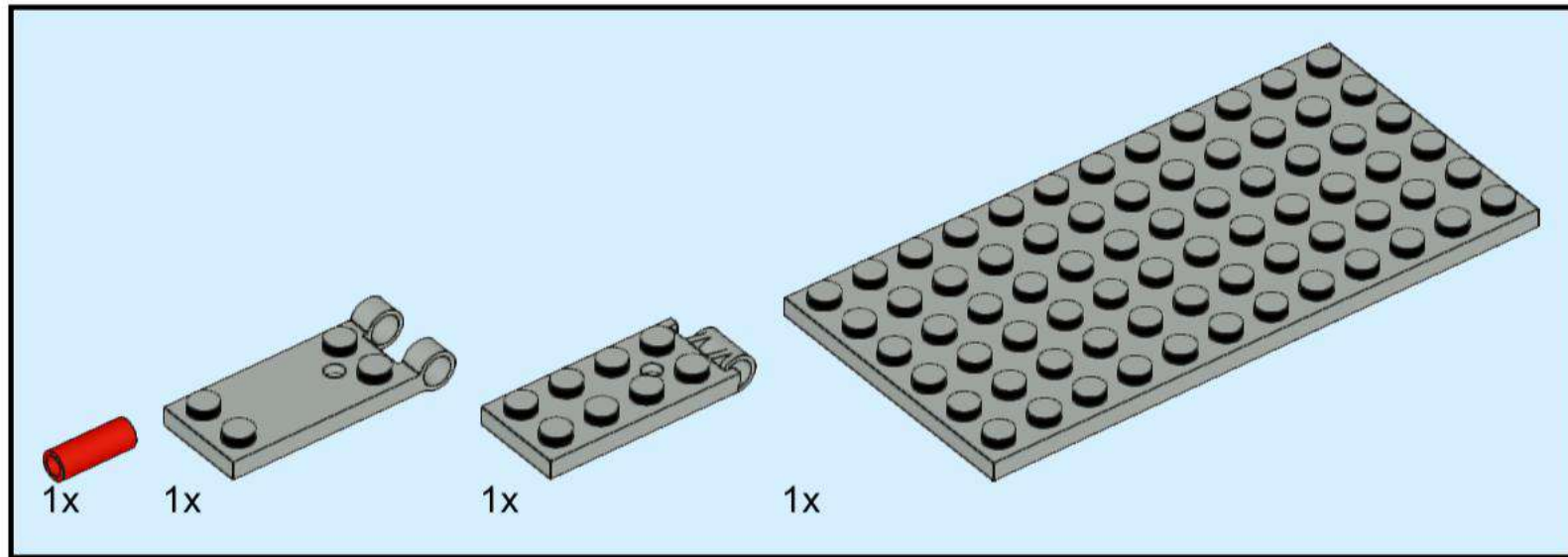

# 26

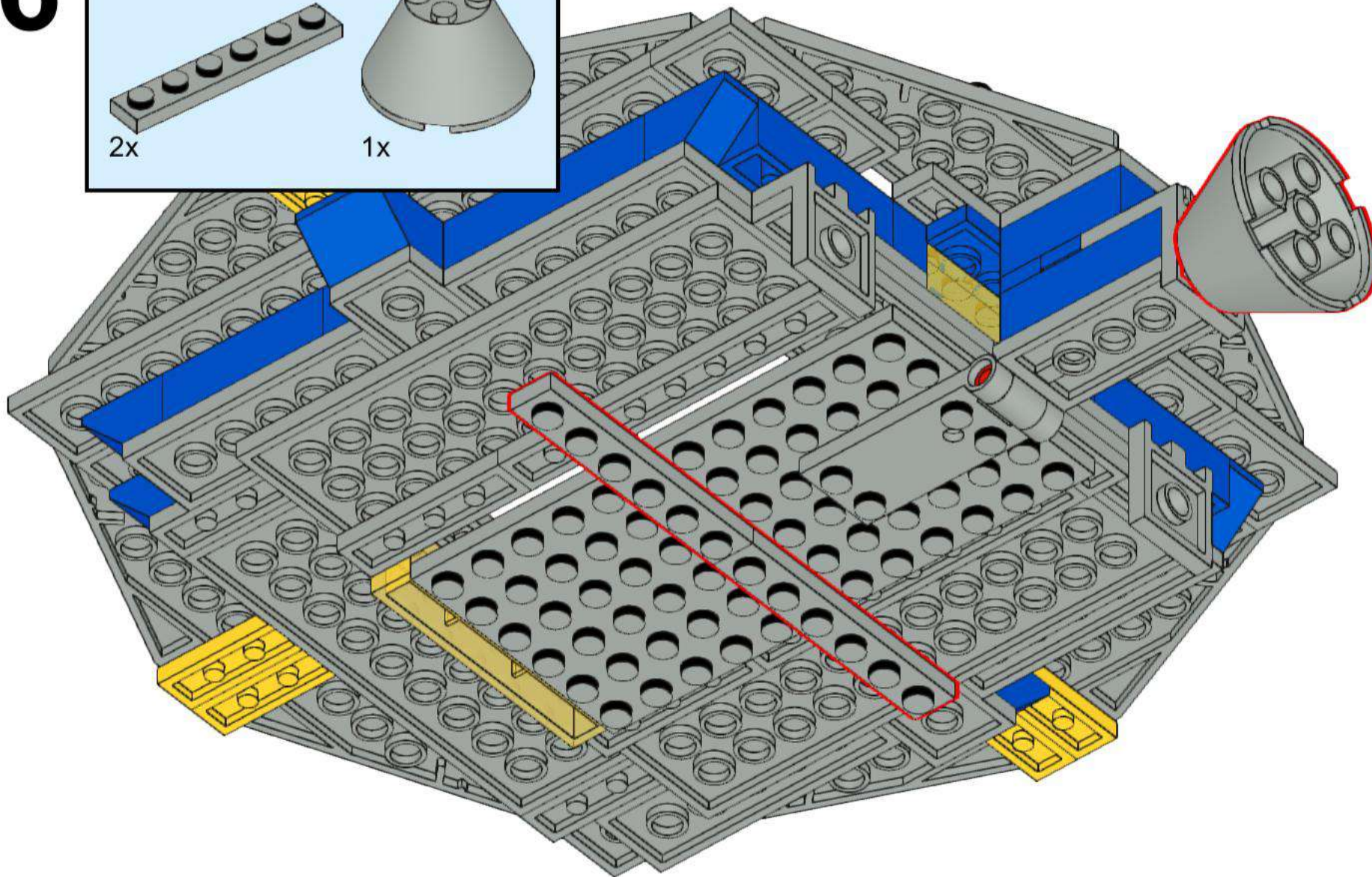
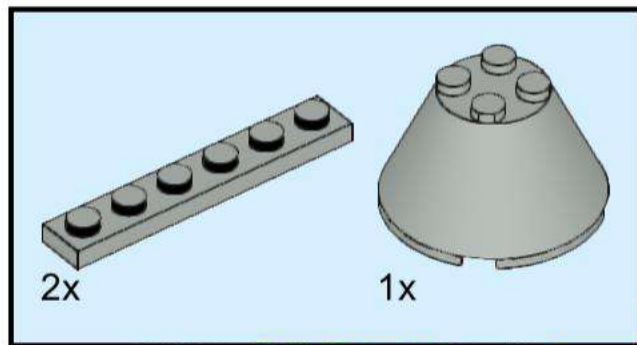

# 27

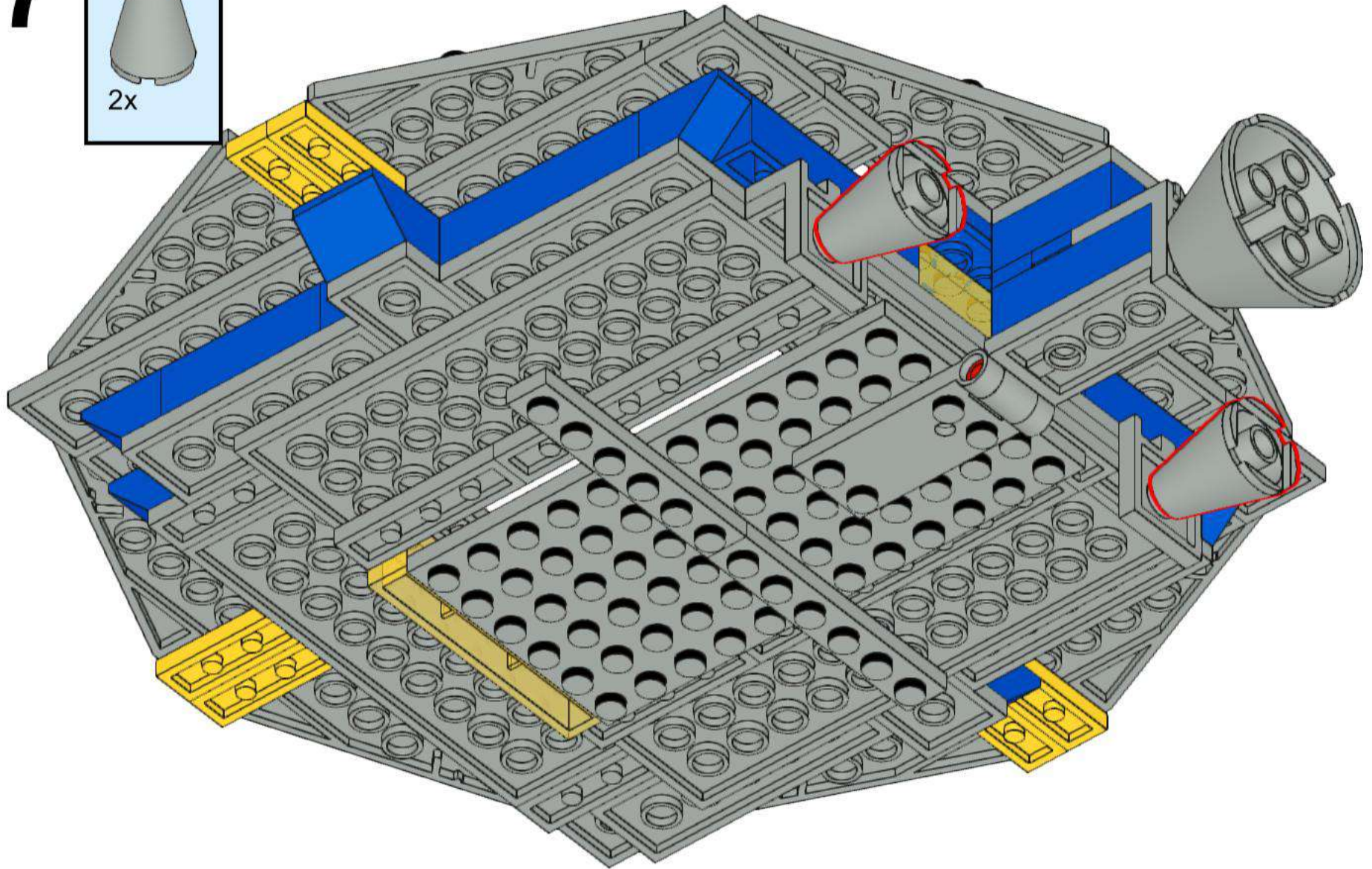
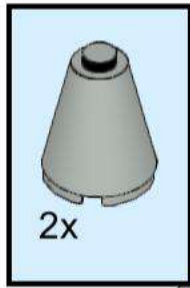

# 28

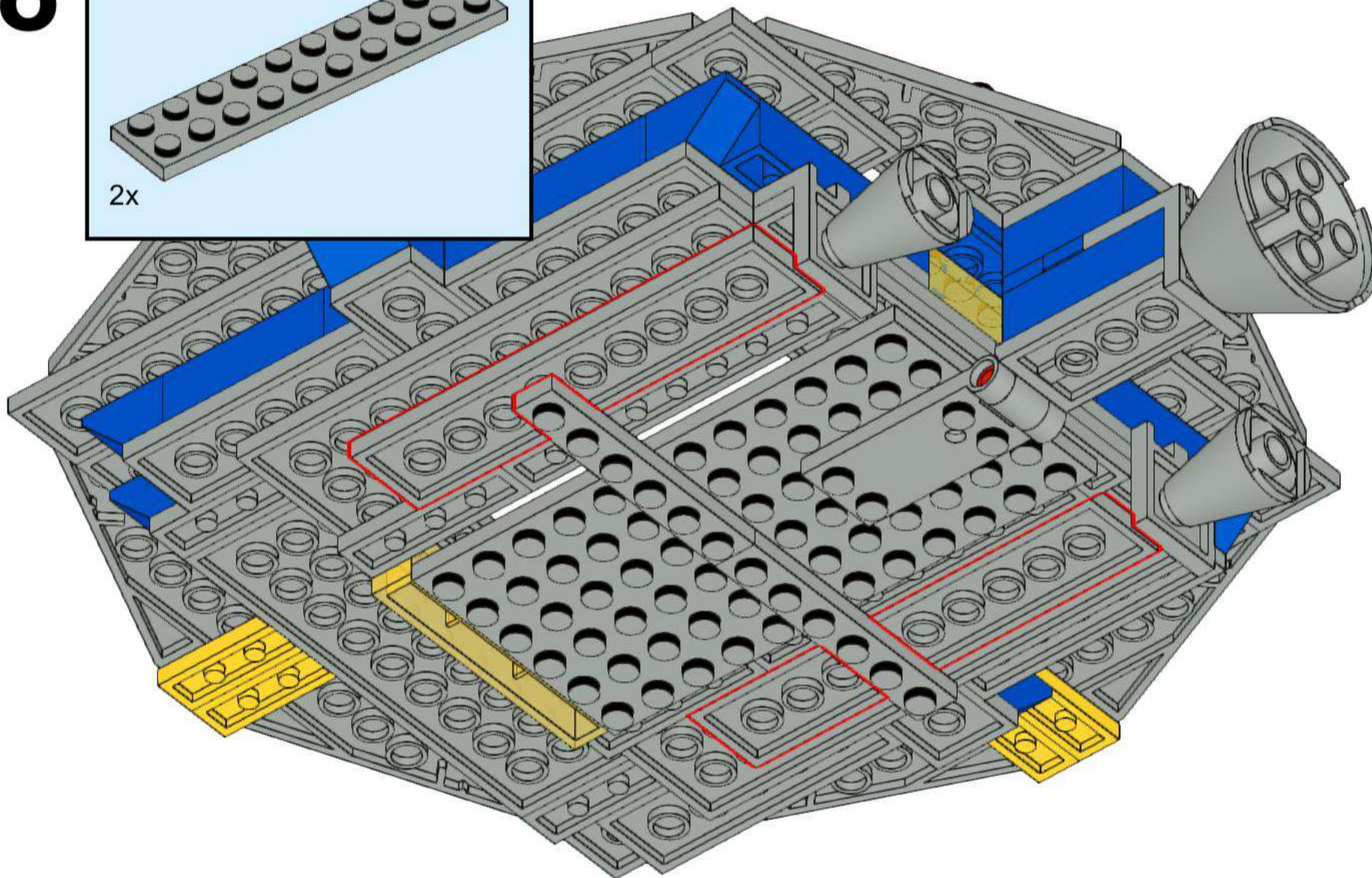
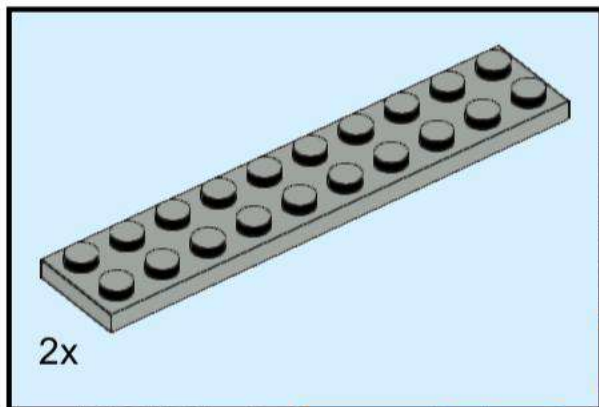

# 29

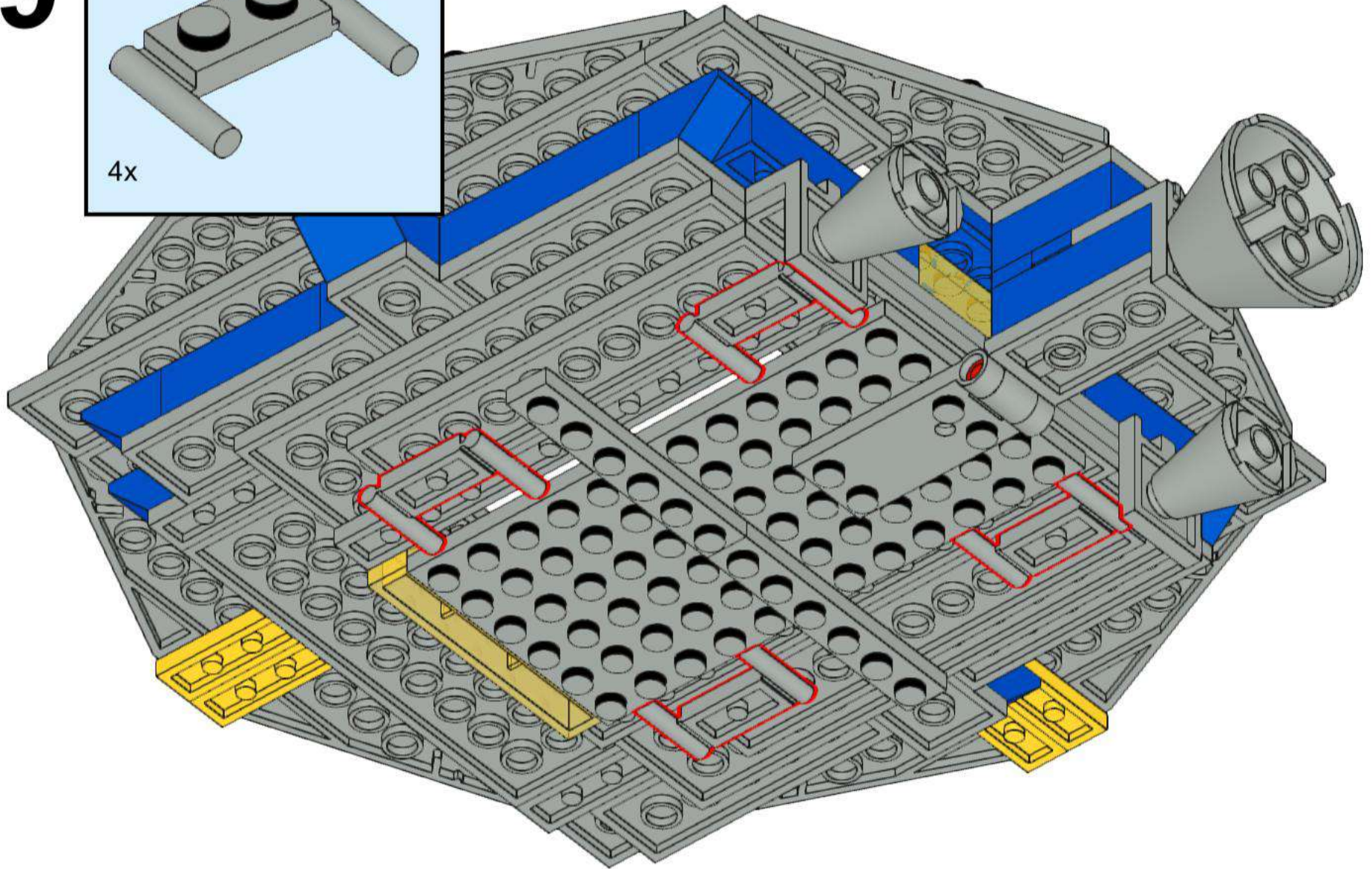
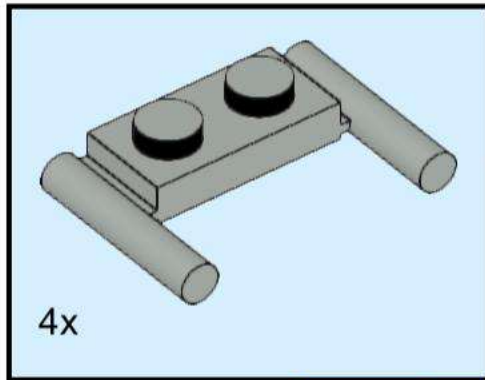

# 30

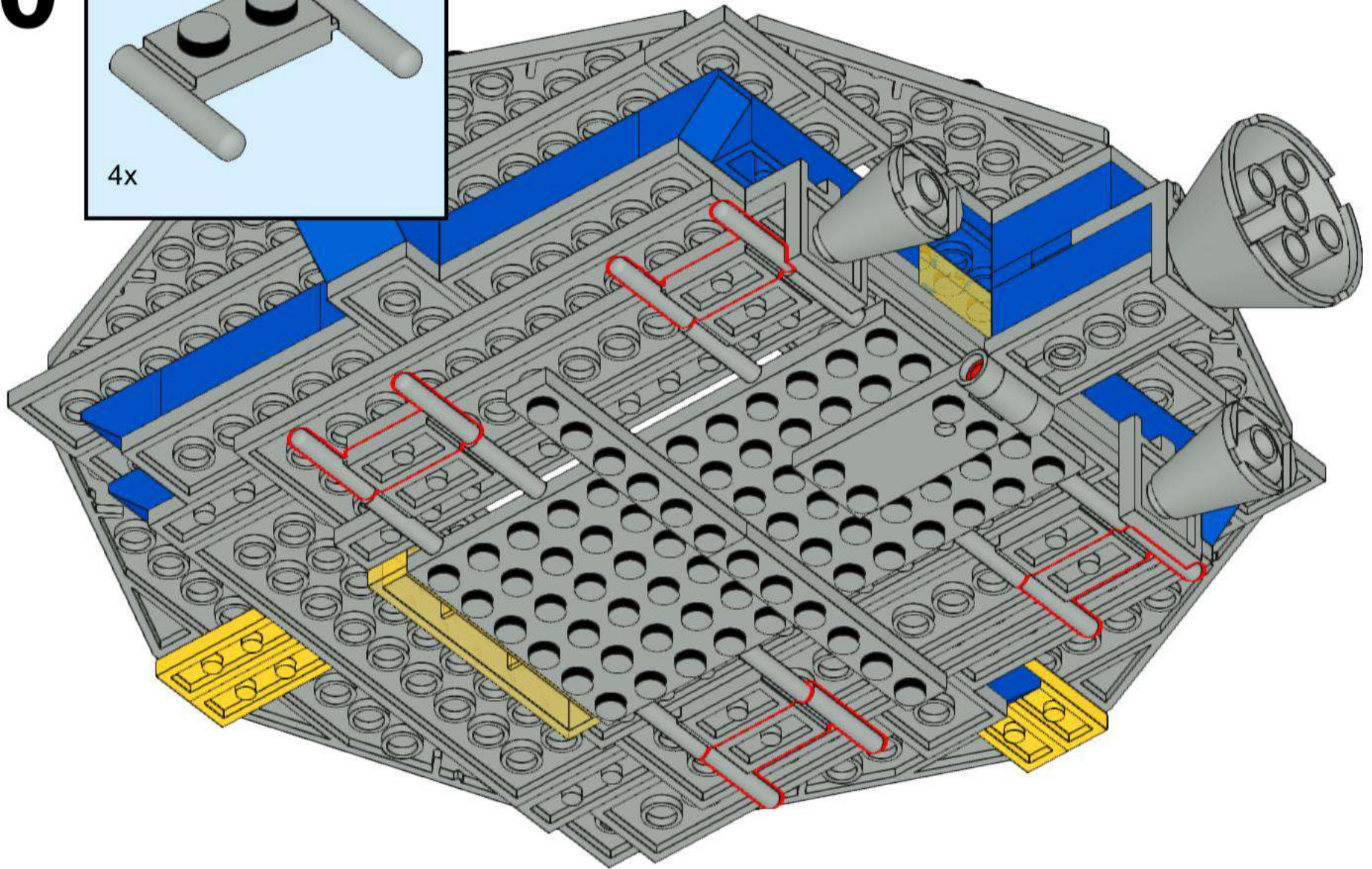
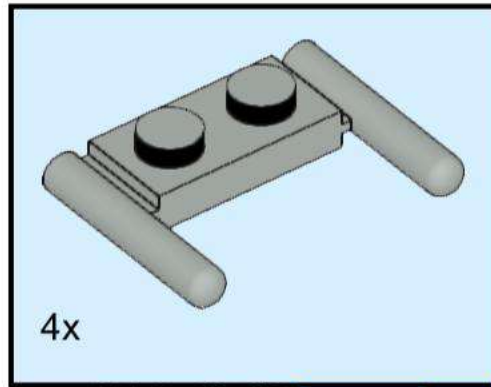

# 31

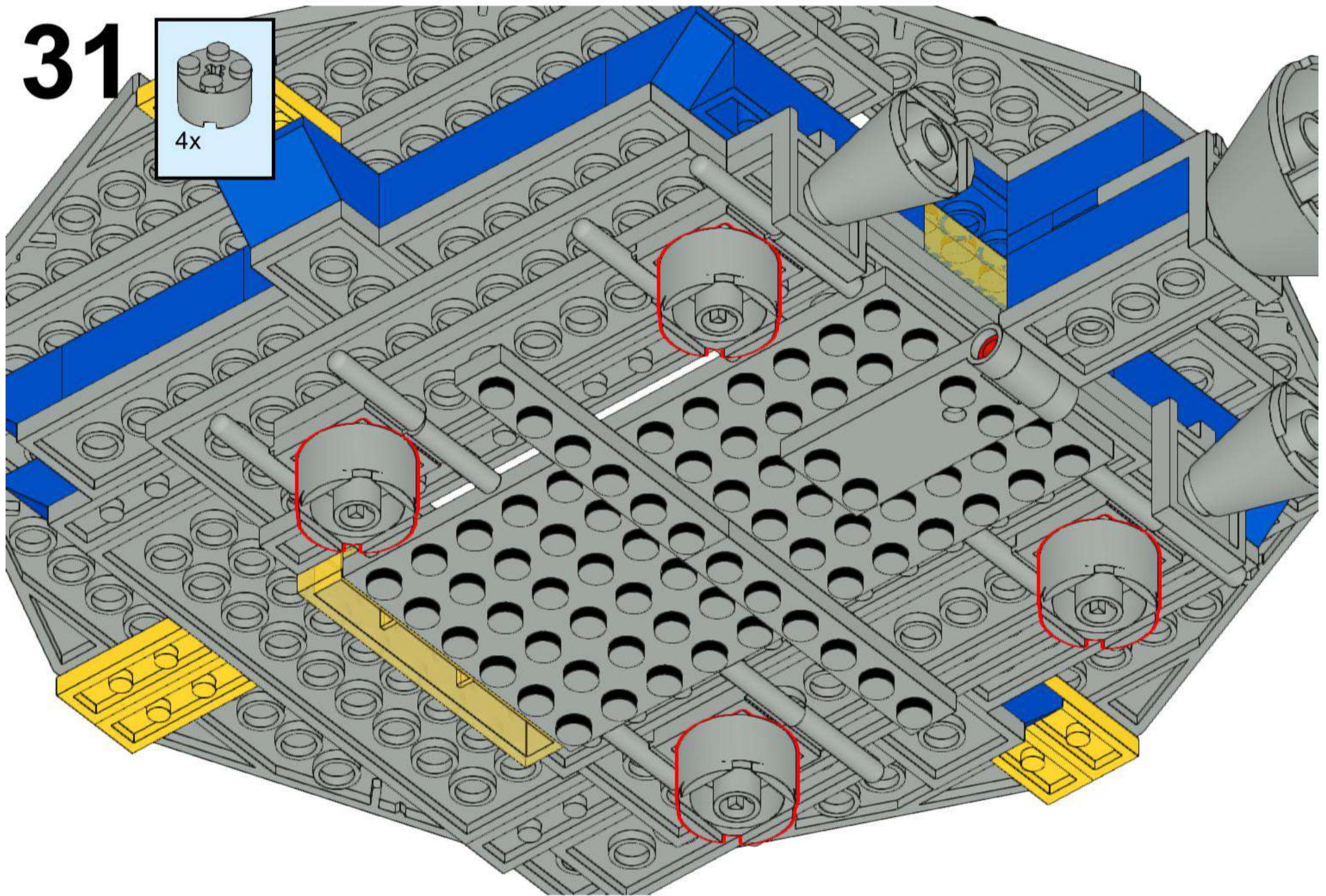
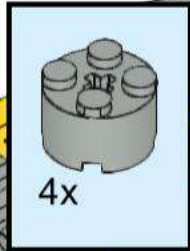

32

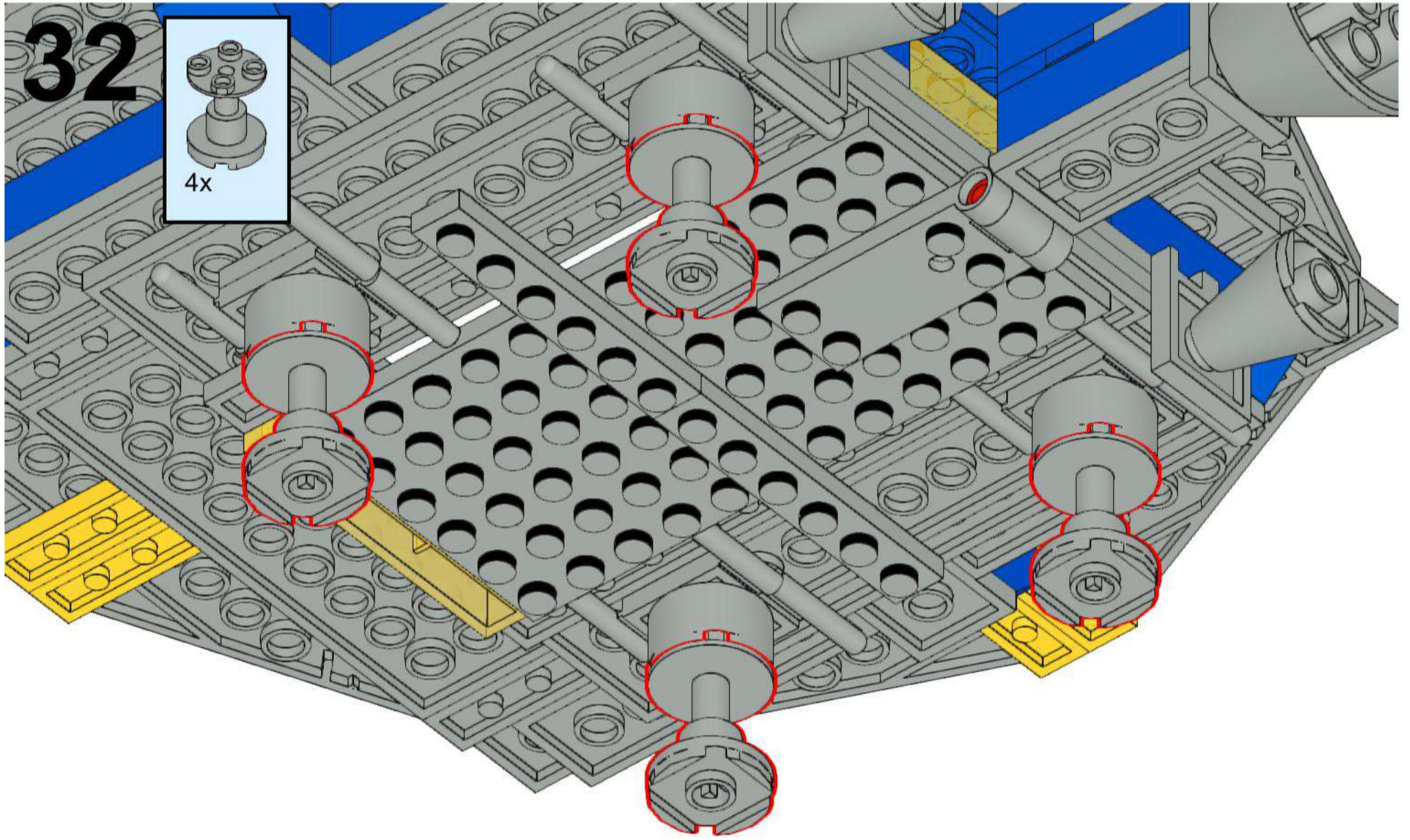



# 33

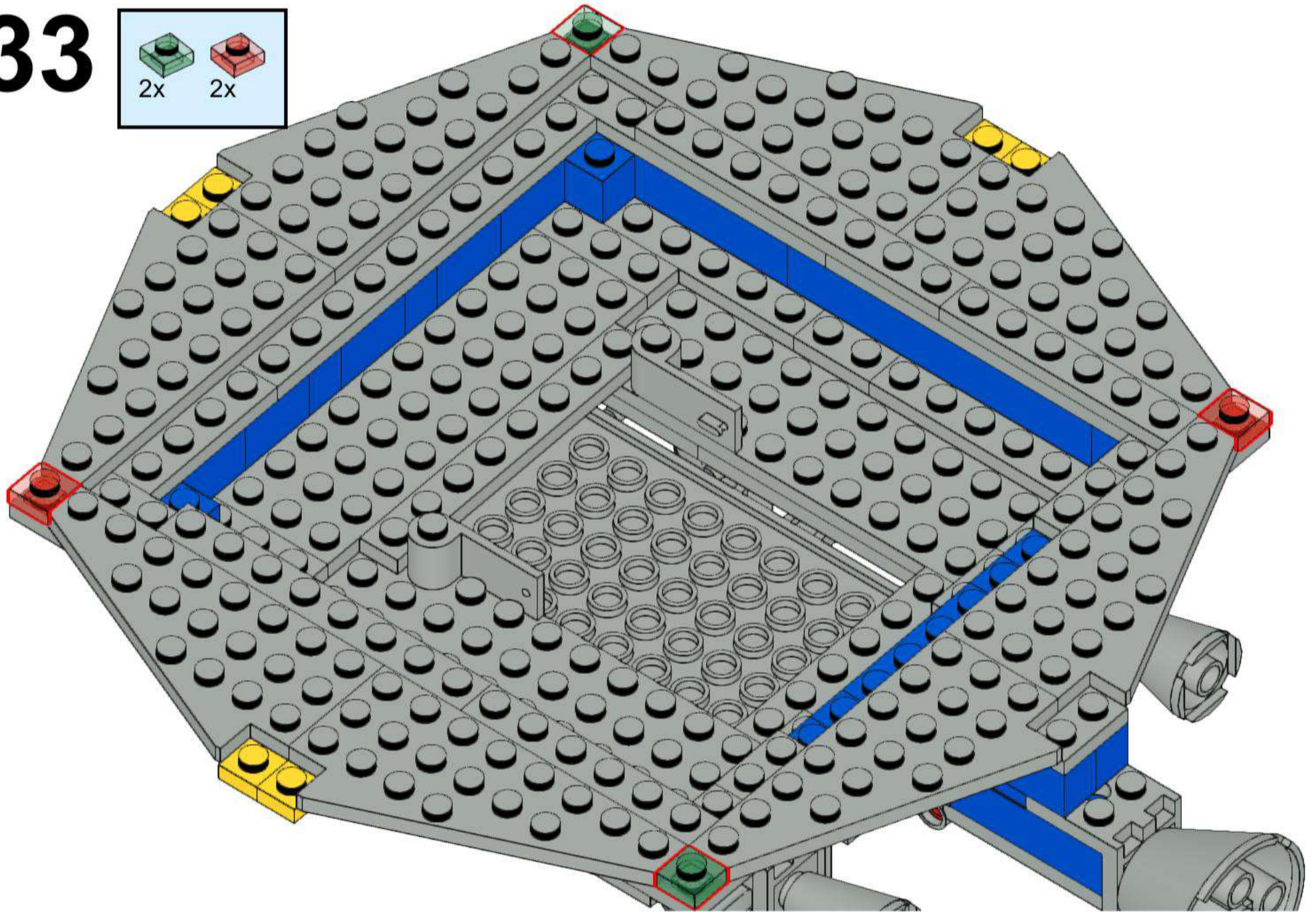
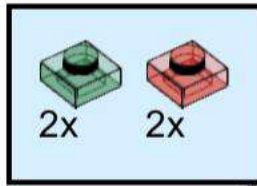

# 34

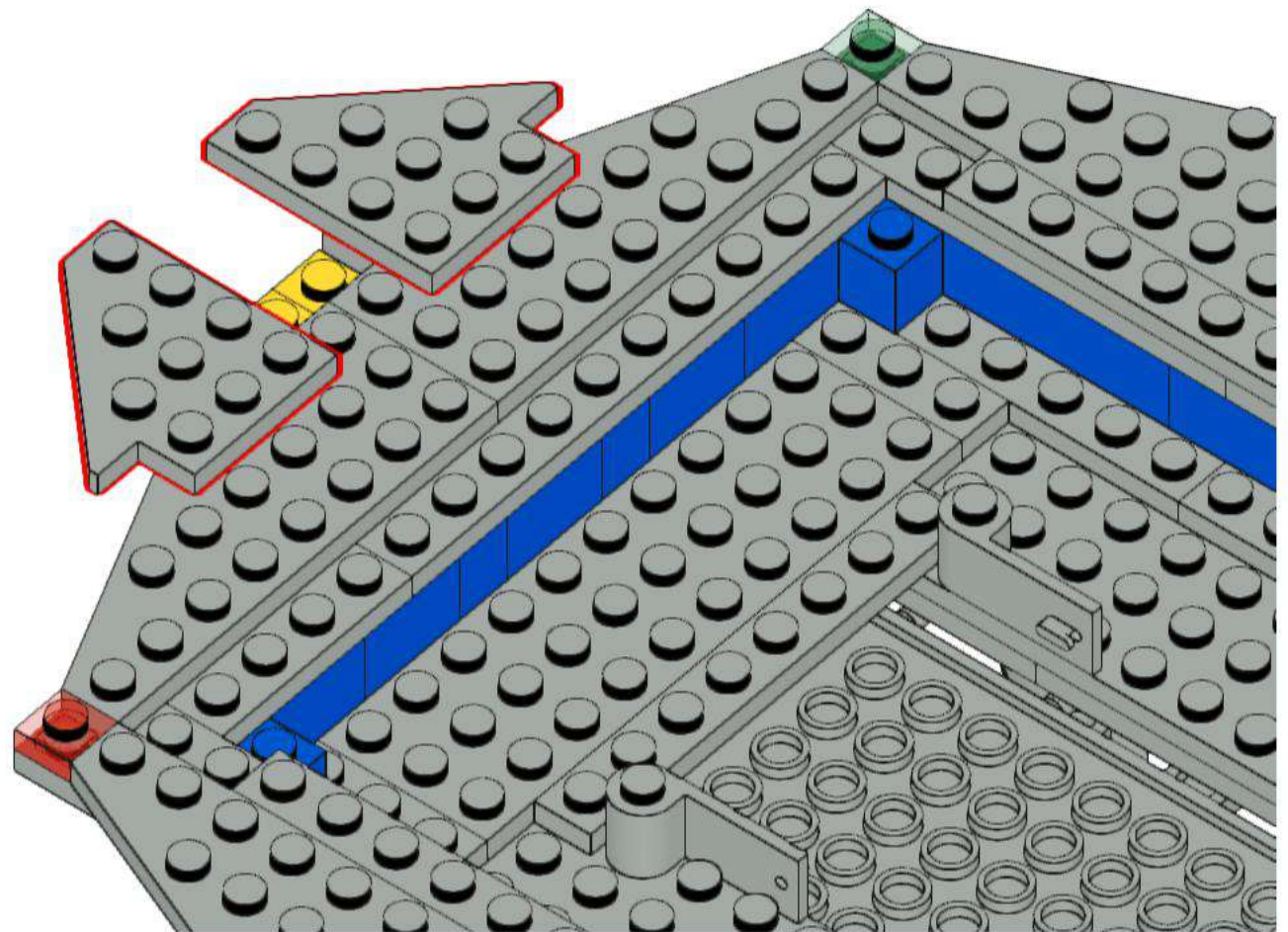
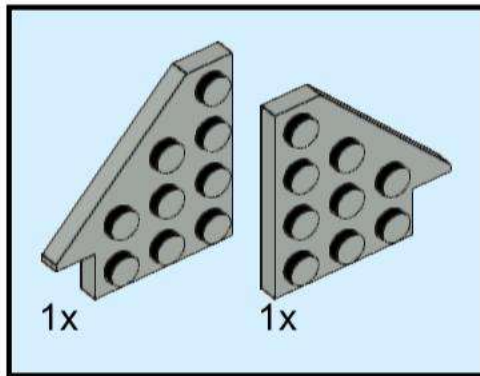

# 35

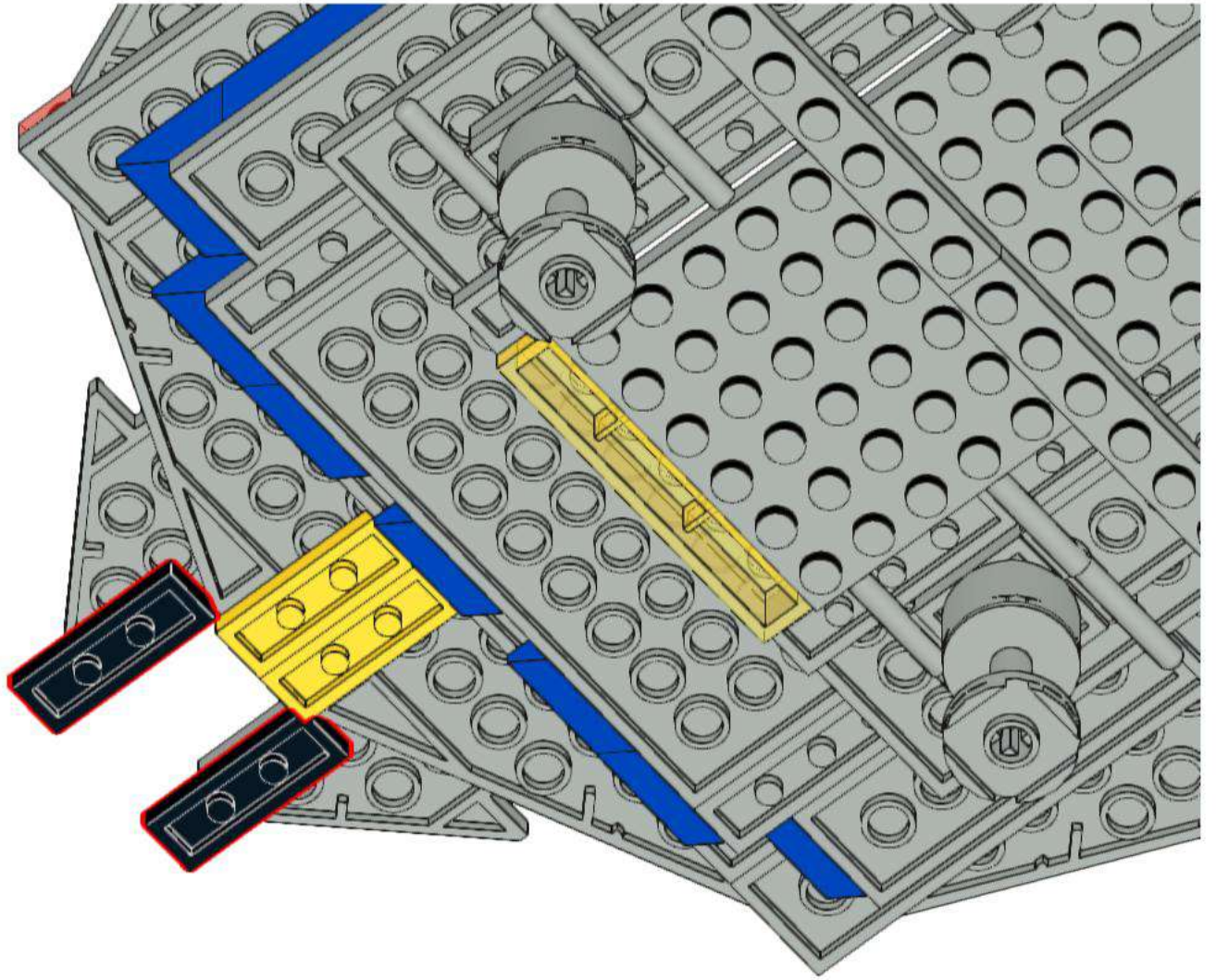
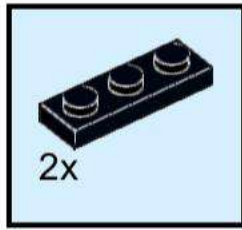

# 36

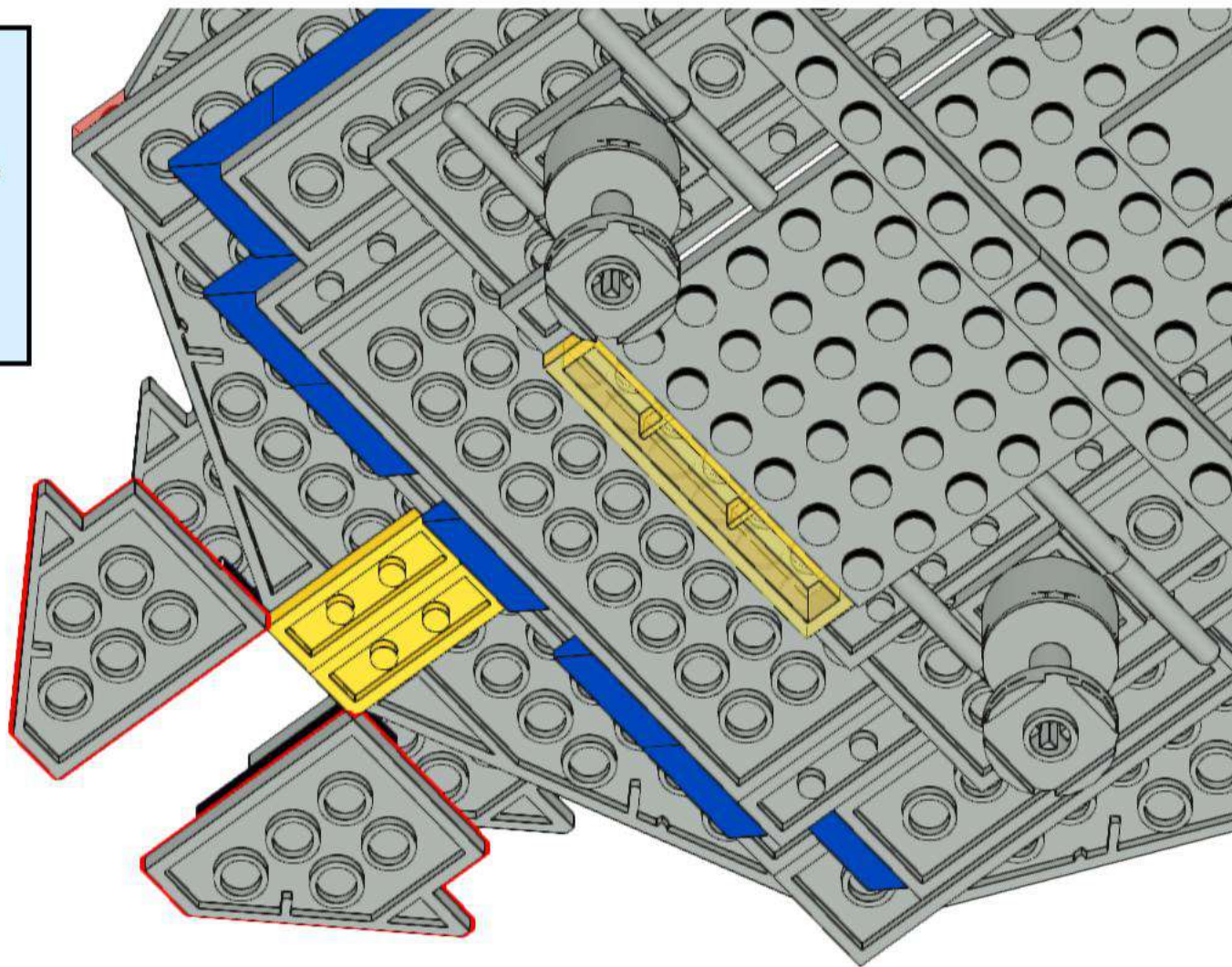
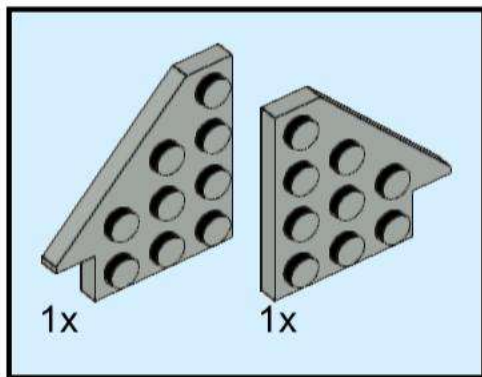

# 37

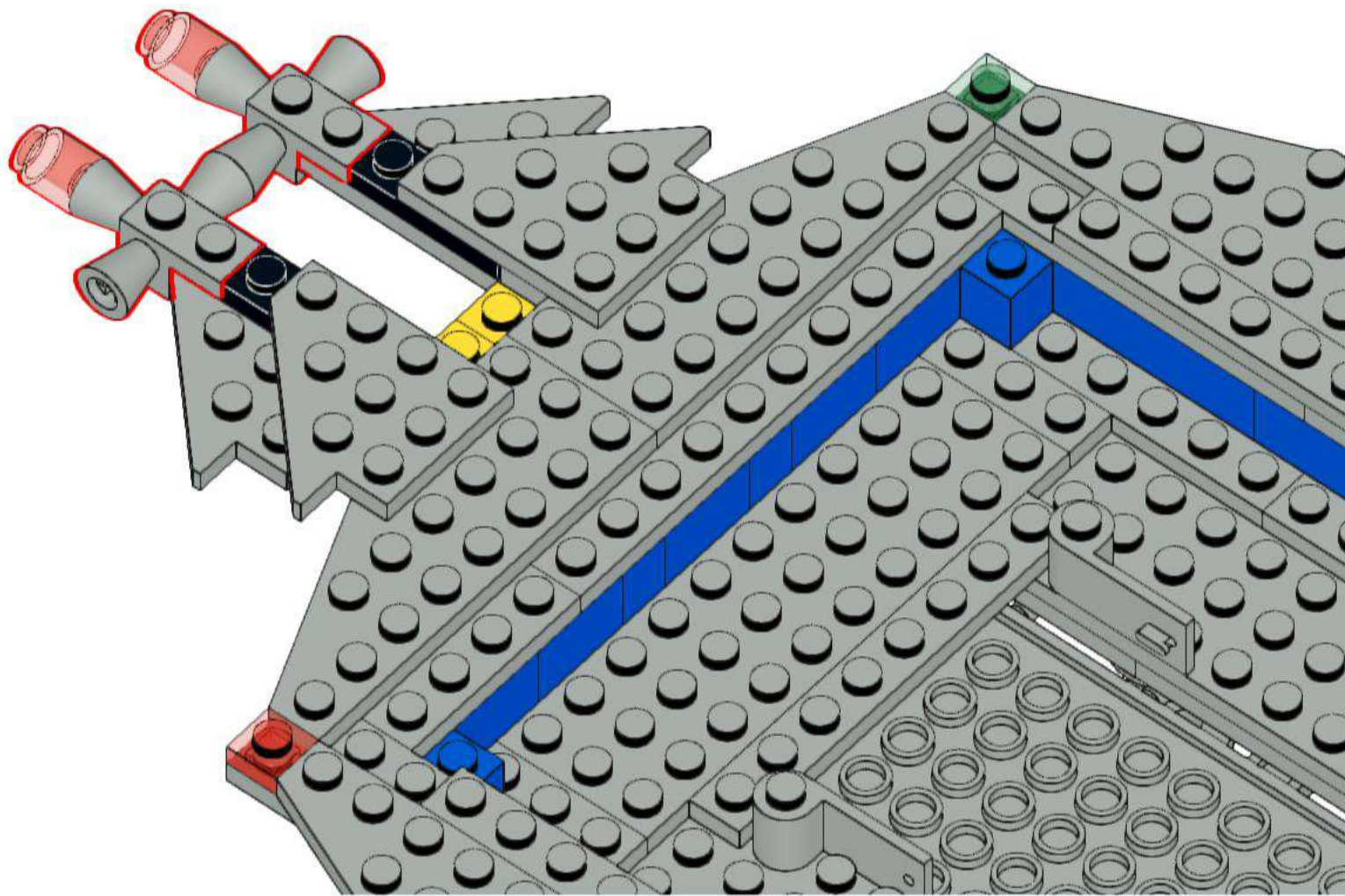
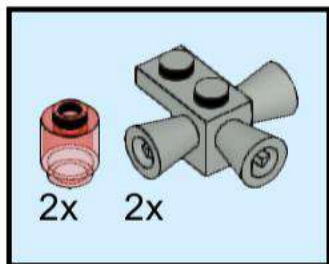

# 38

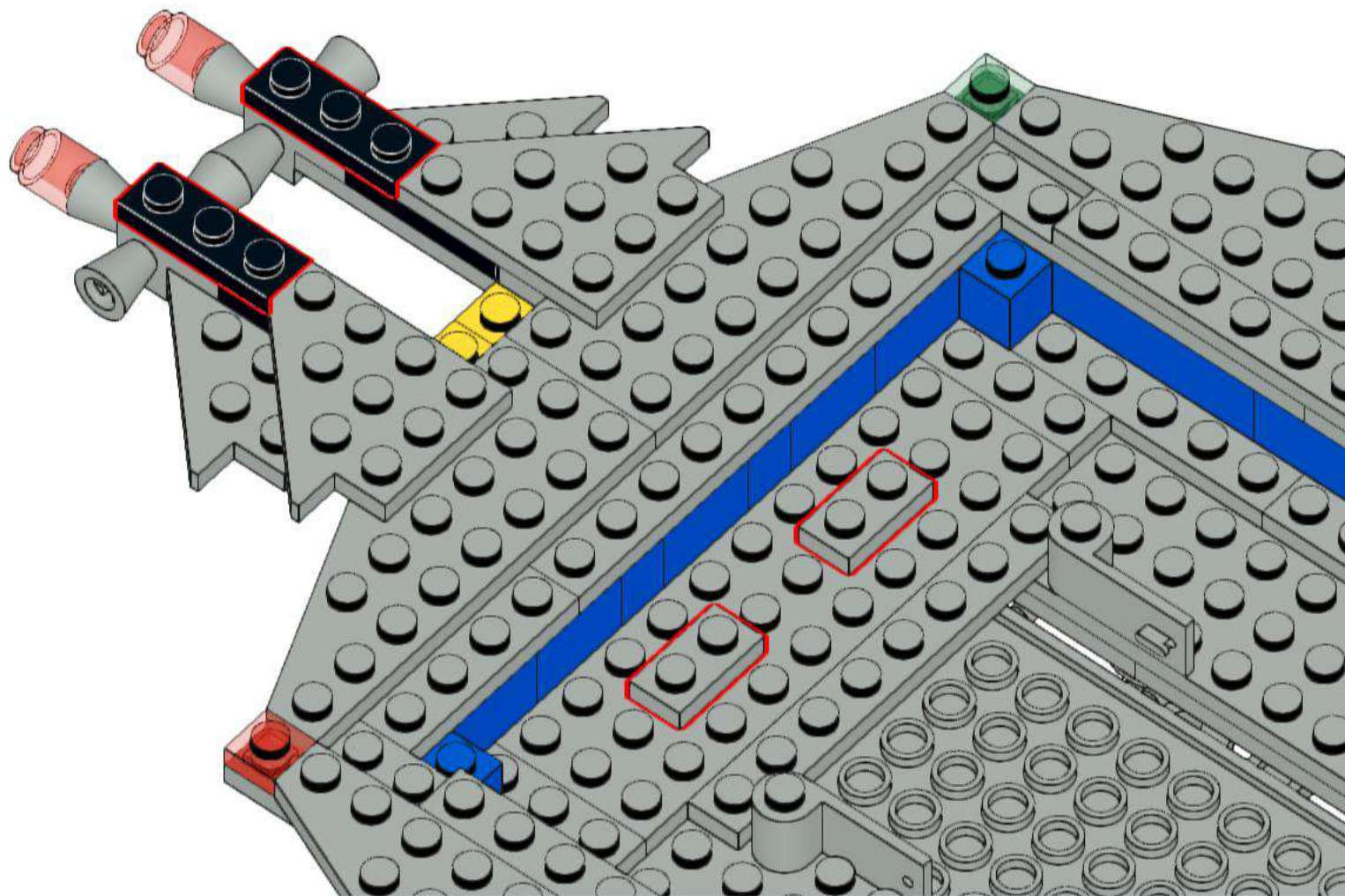
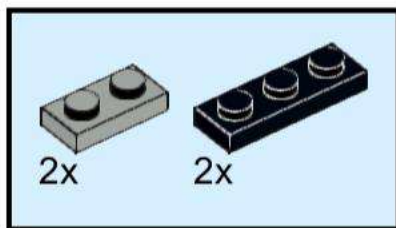



# 40

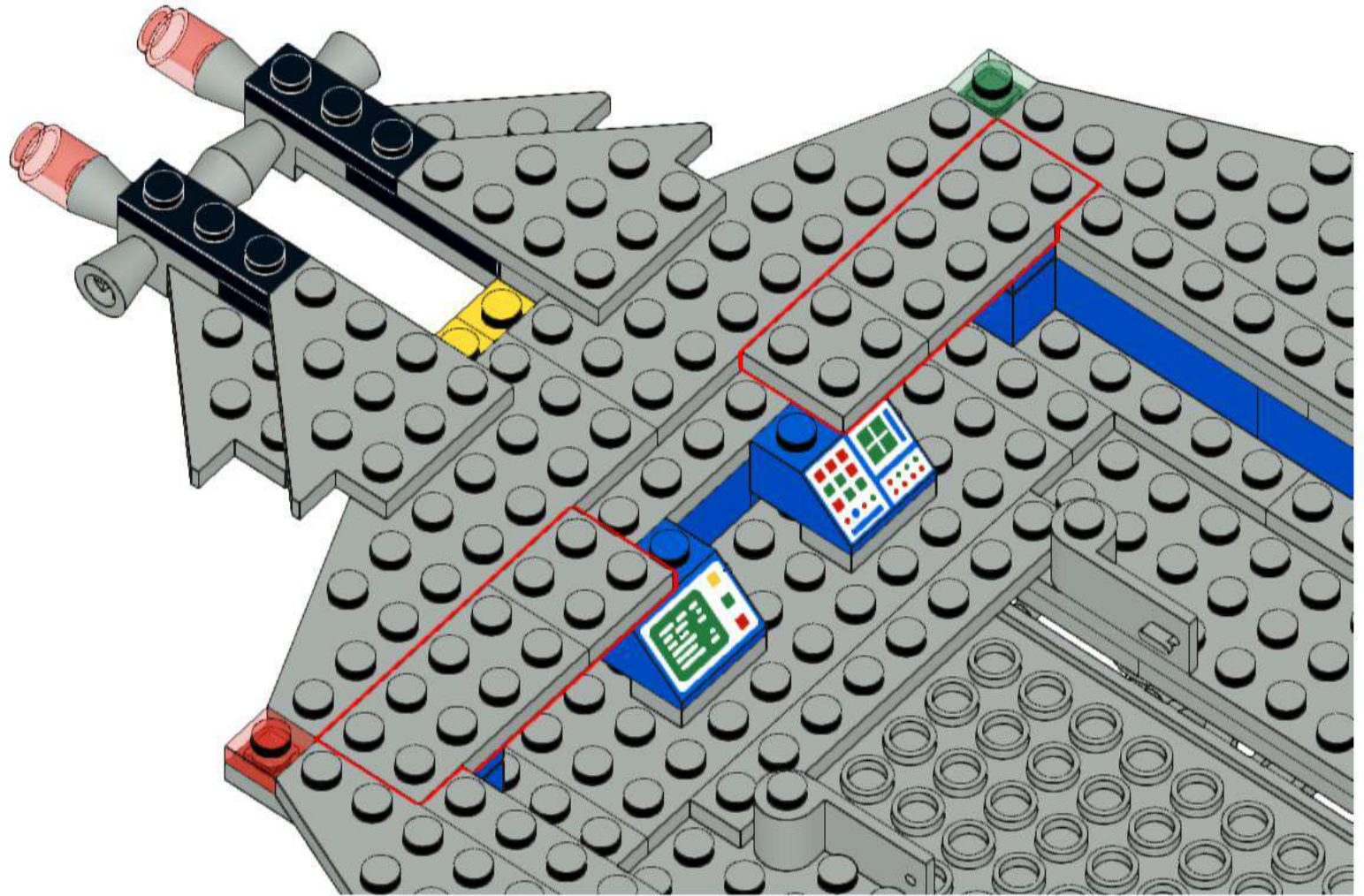
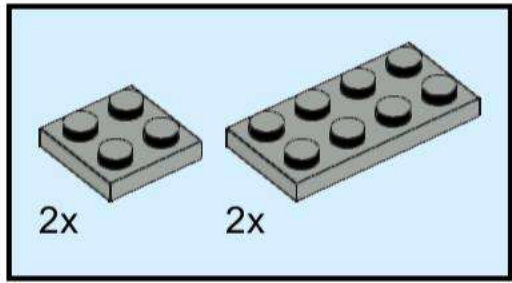







# 43

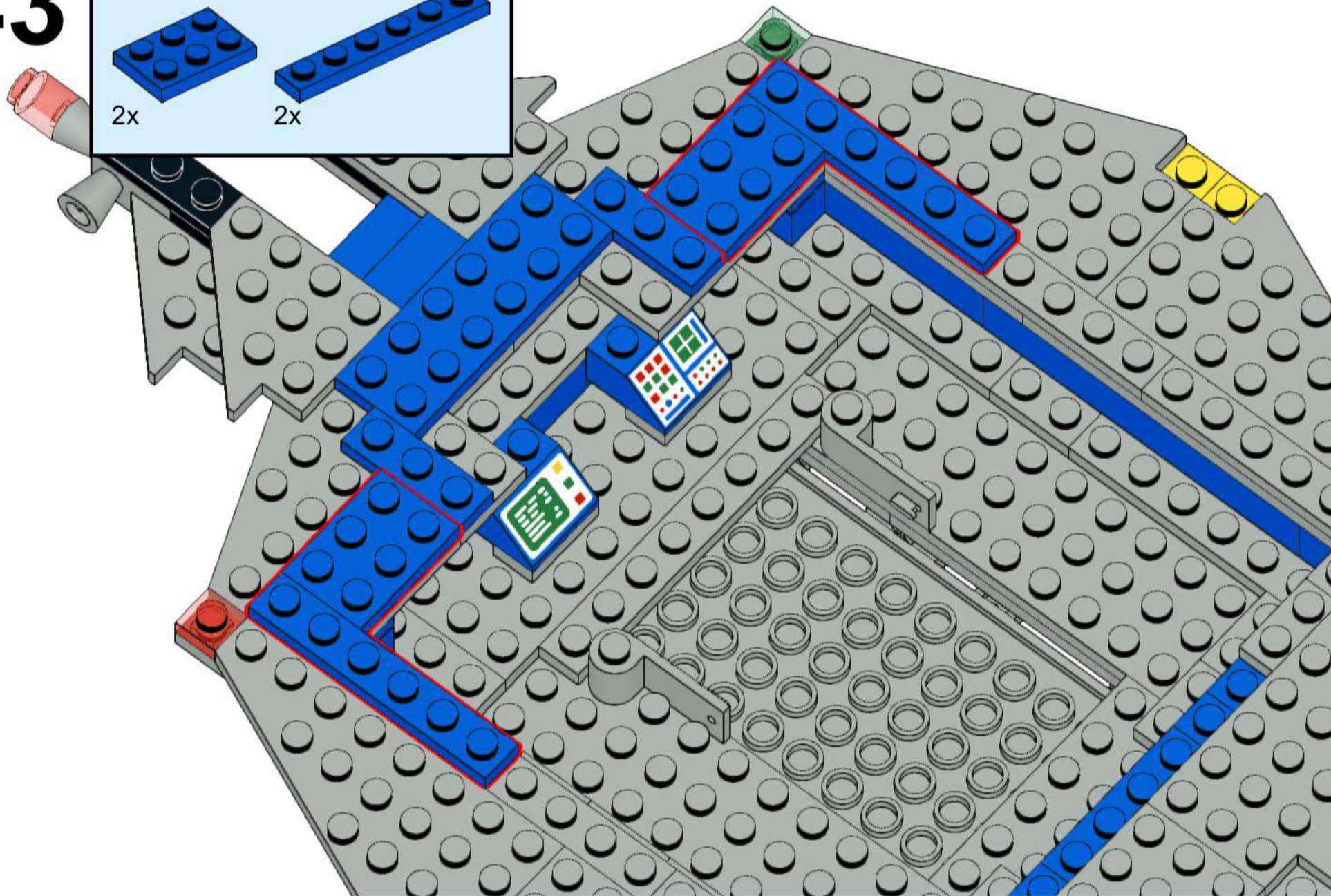
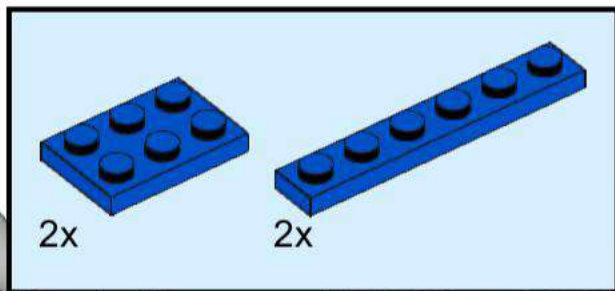

# 44

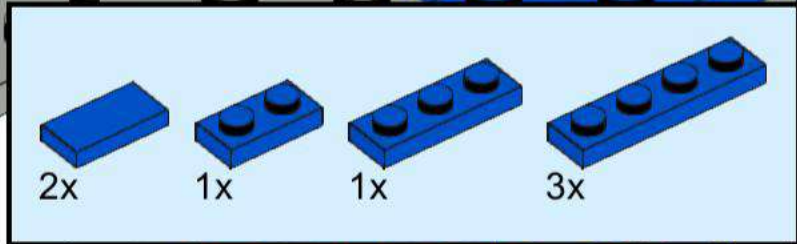

2x  
1x  
1x  
3x

This inset box shows the parts list for step 44. It contains four blue Technic beams: a 2-hole beam (2x), a 3-hole beam (1x), a 4-hole beam (1x), and a 5-hole beam (3x). The quantities are listed below each beam.

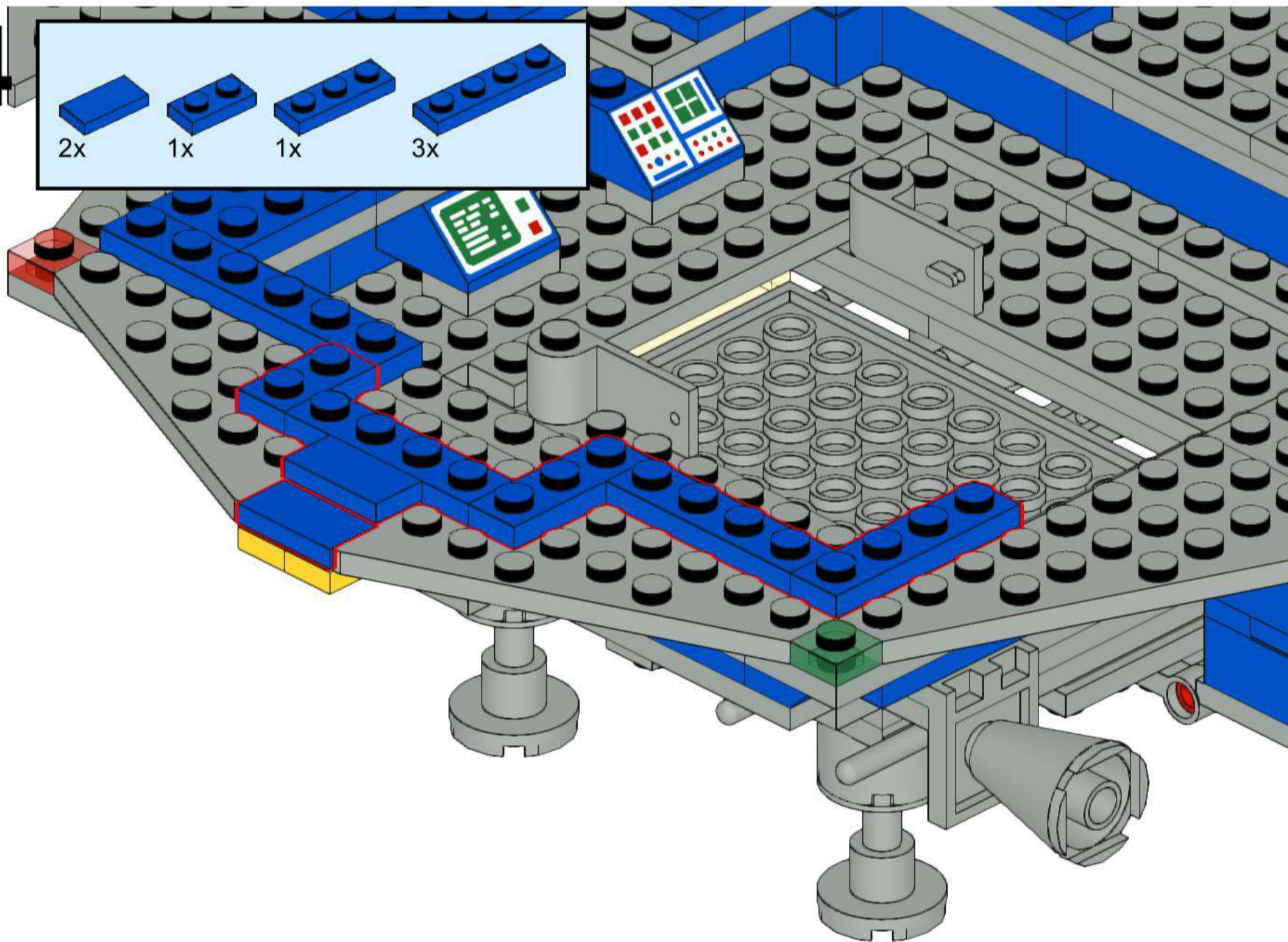

45

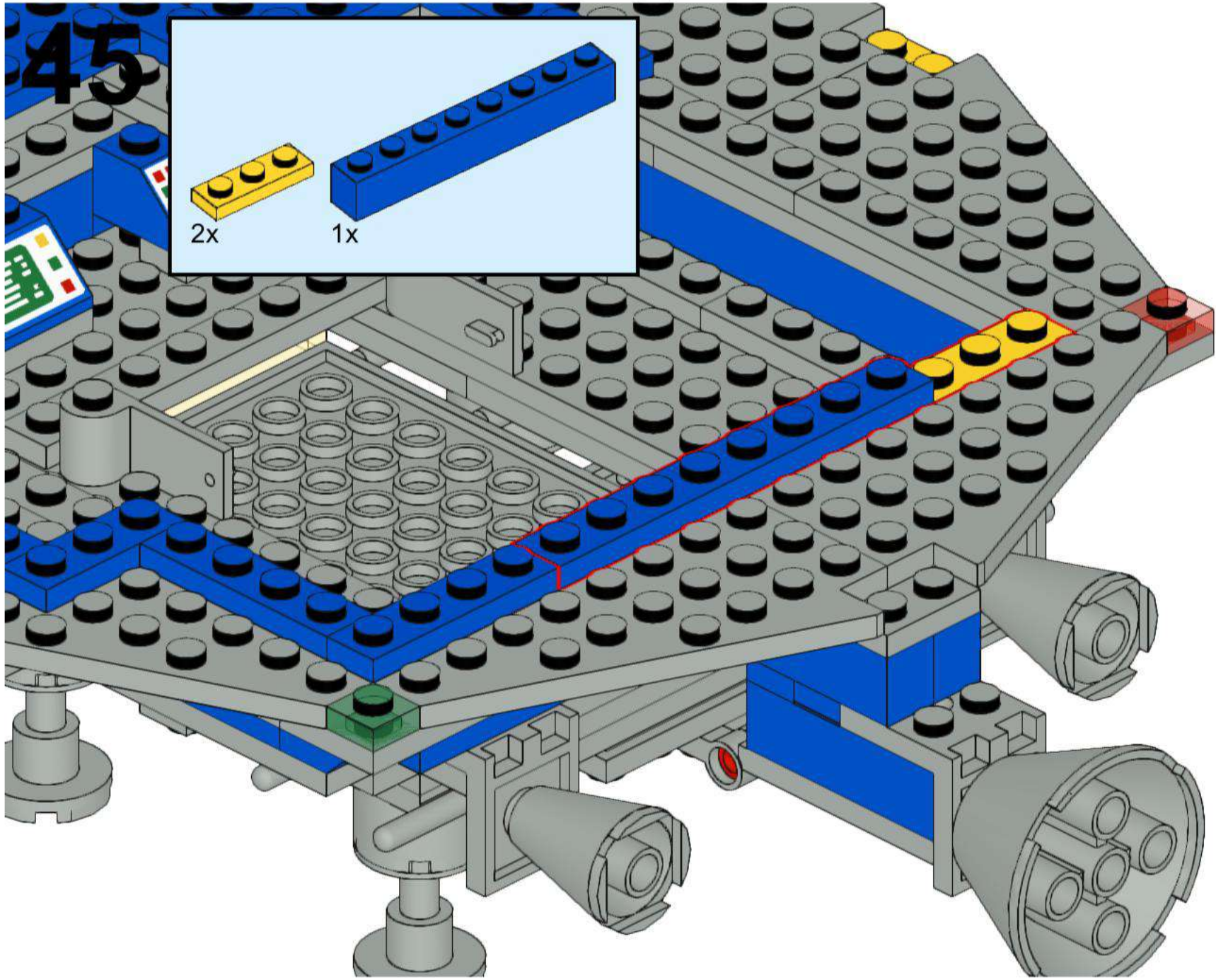
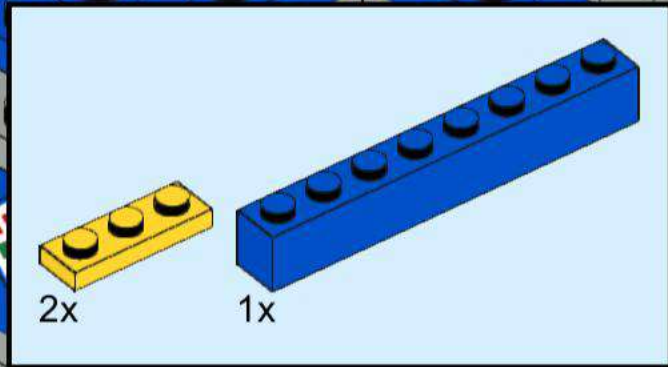

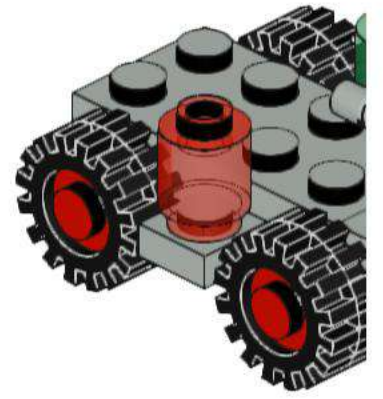
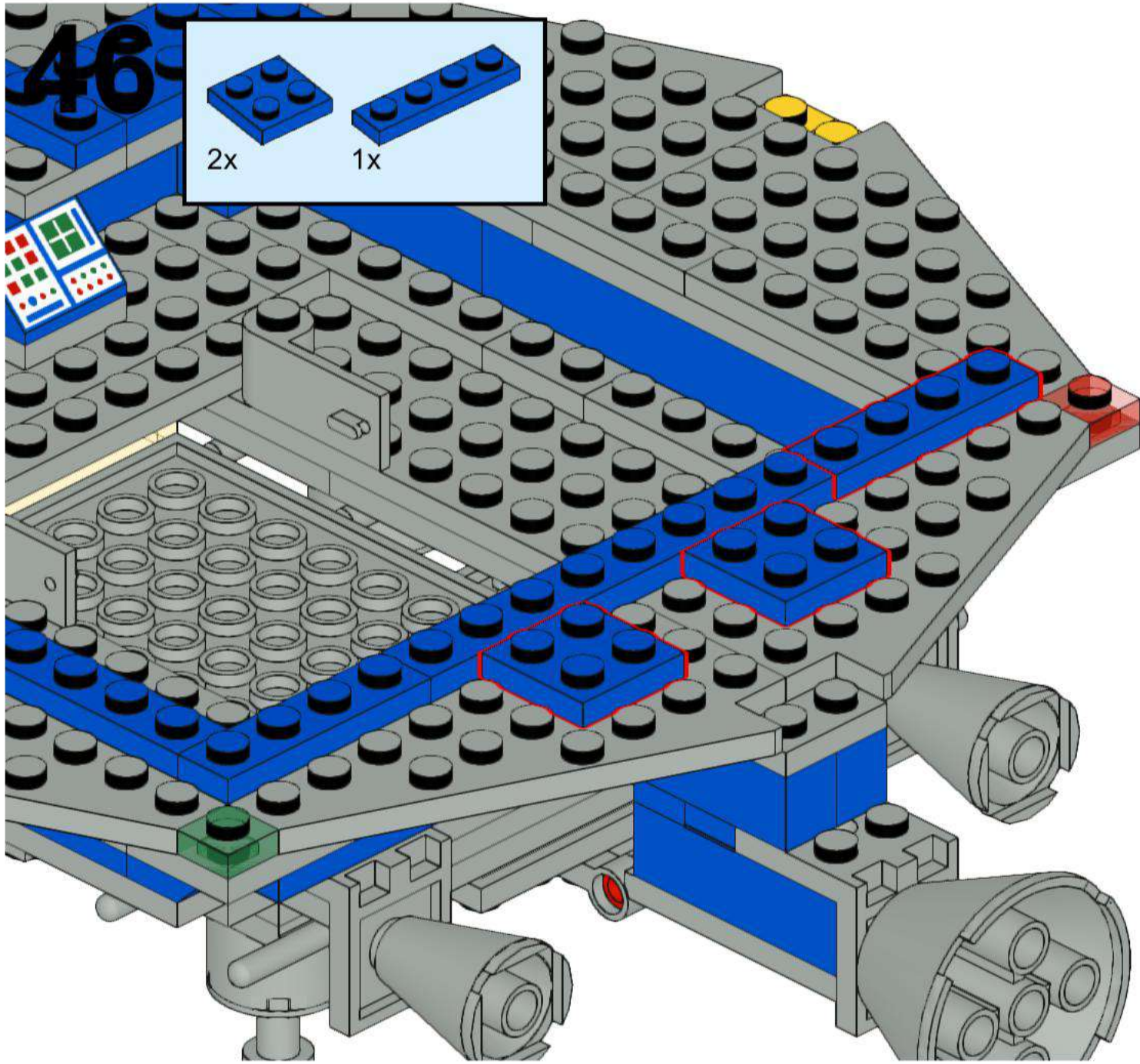

# 47

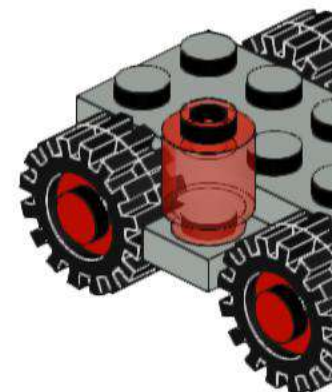
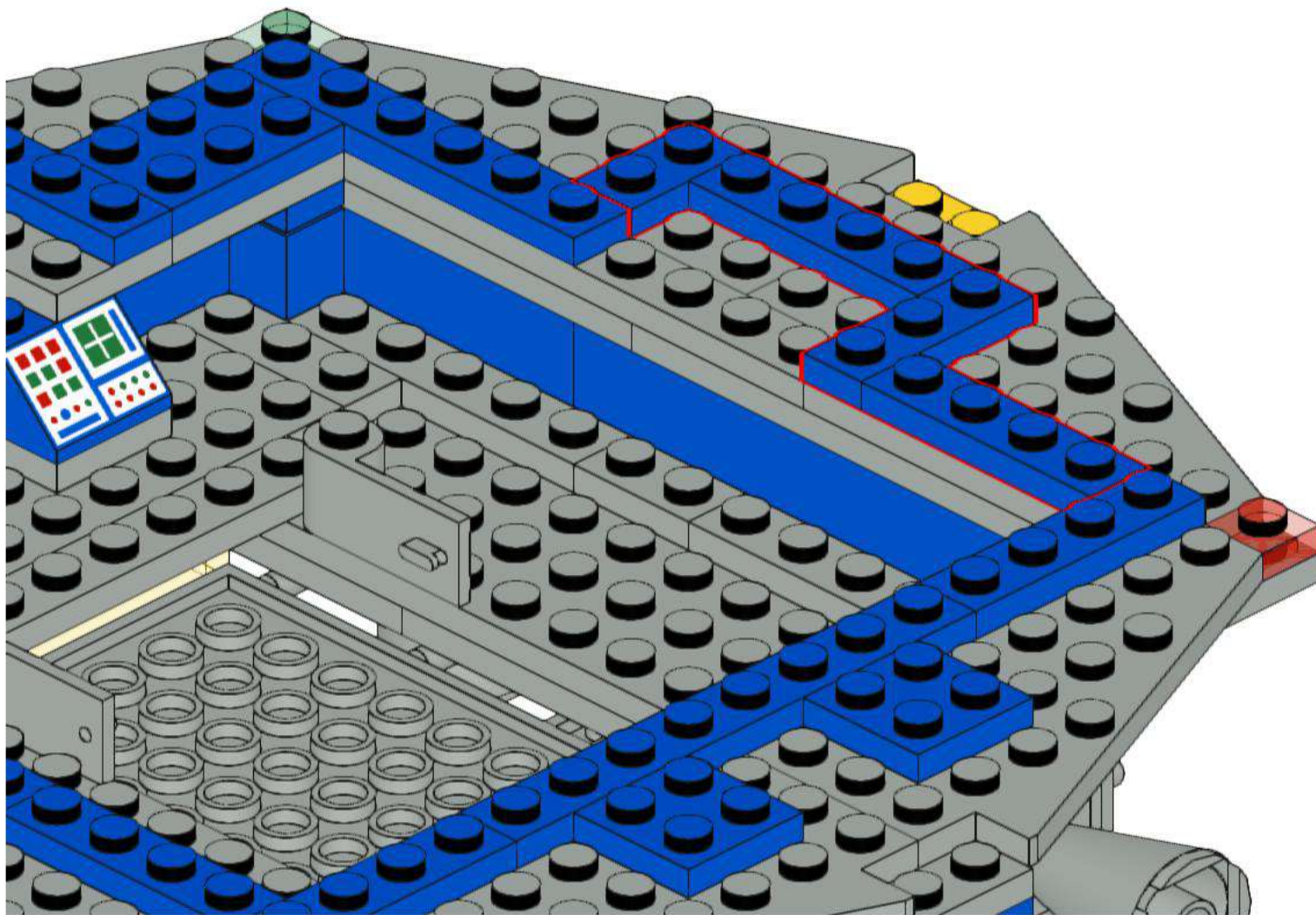
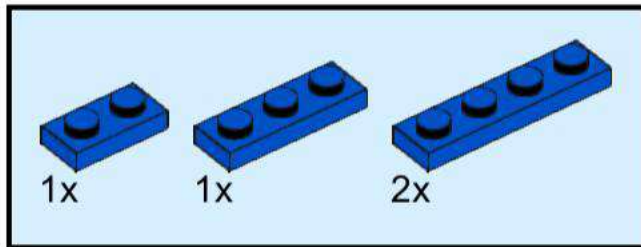

48

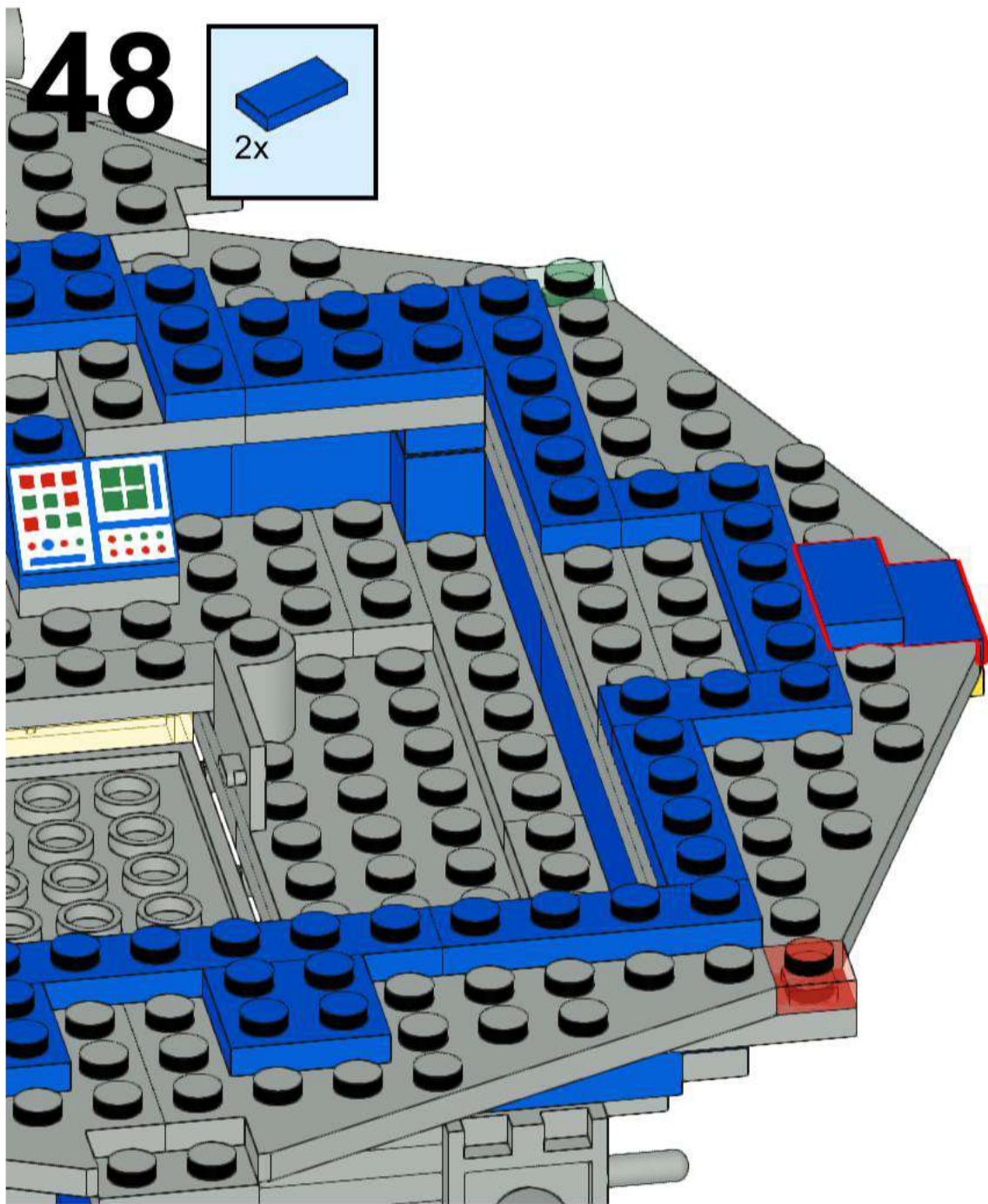
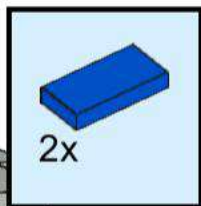



# 49

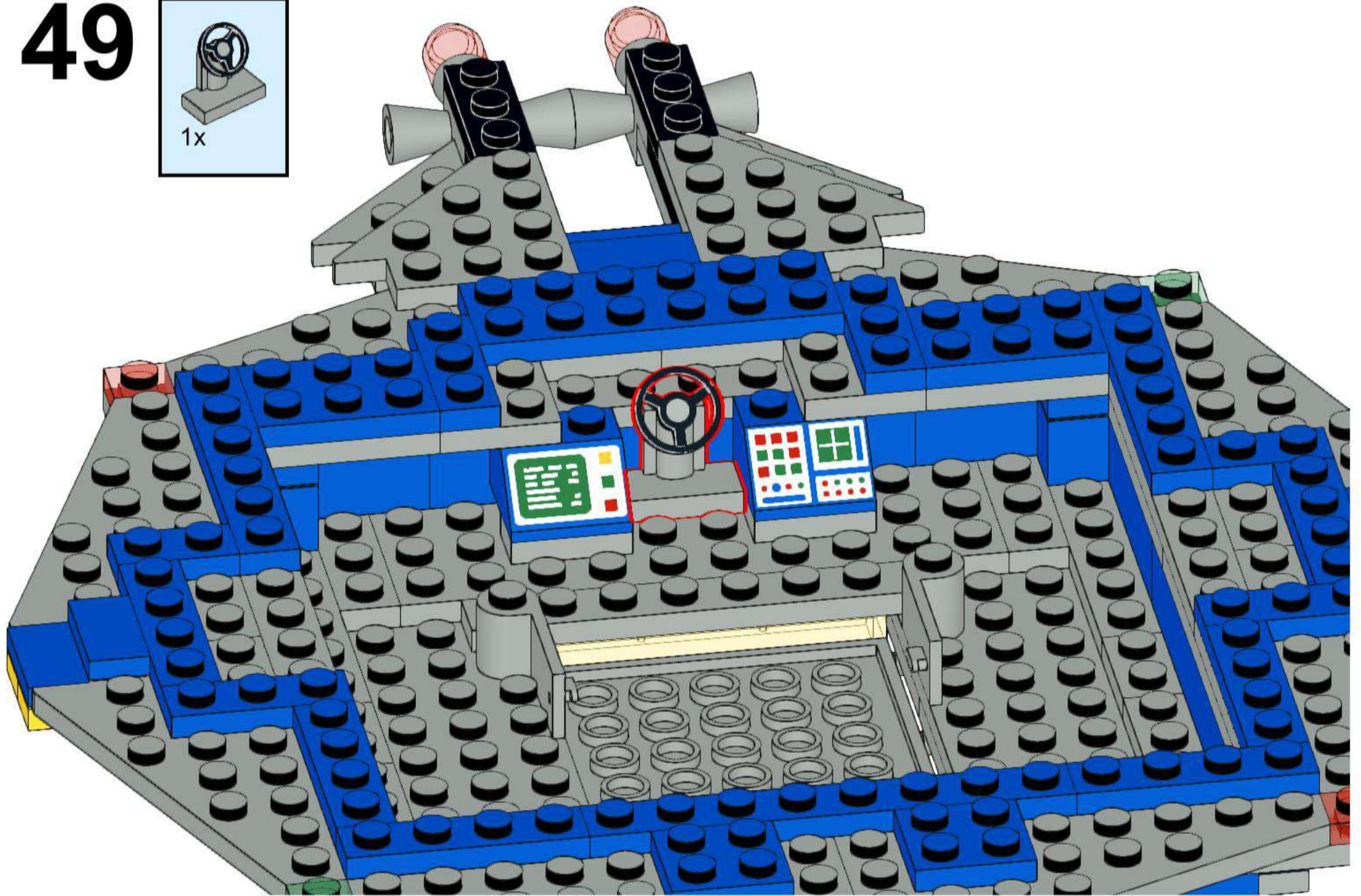
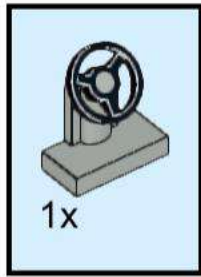

# 50

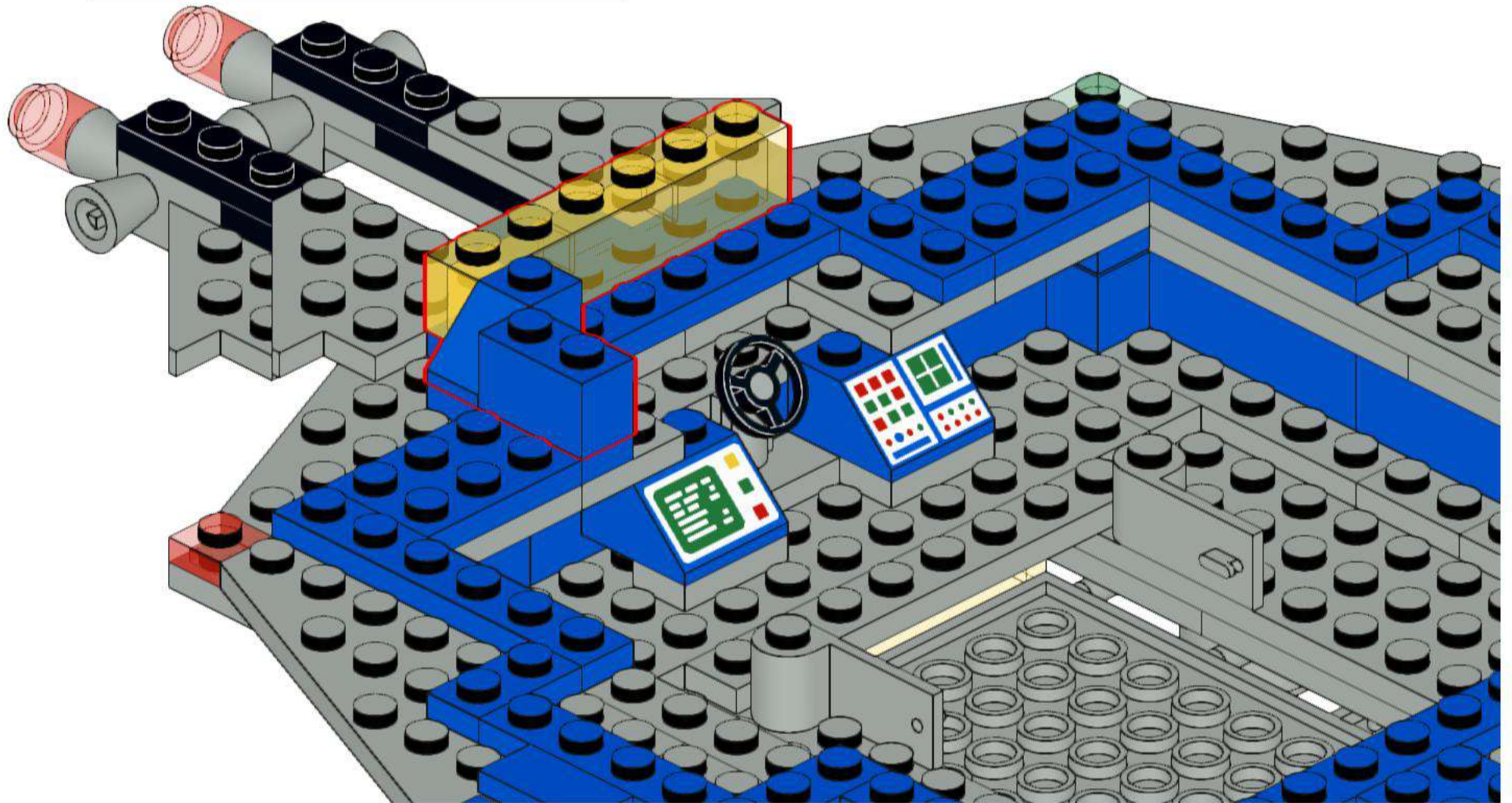
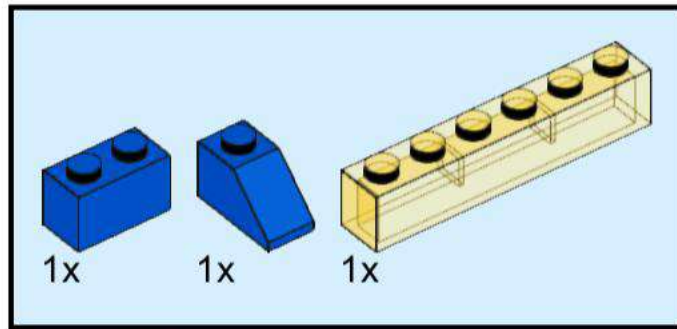

# 51

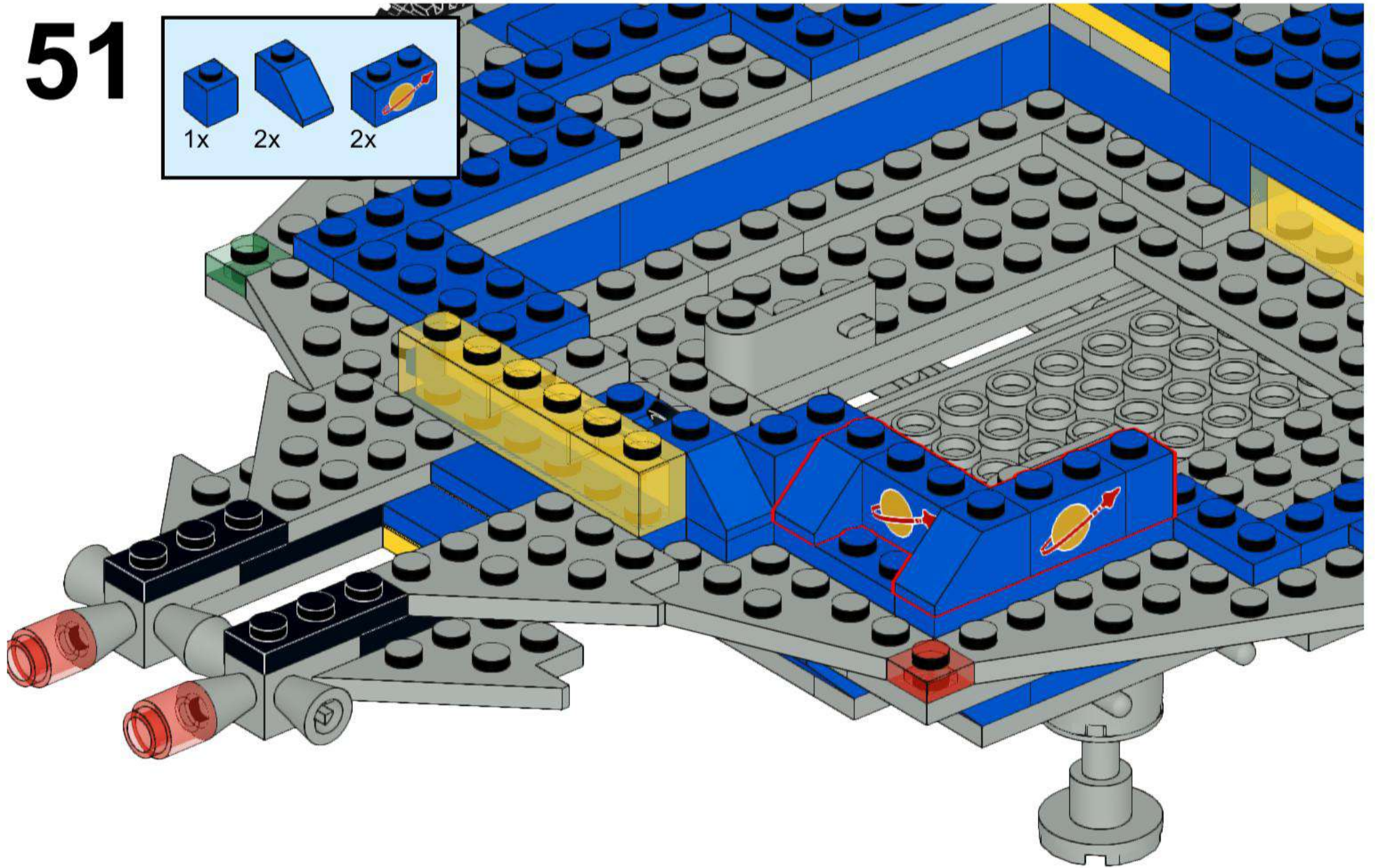
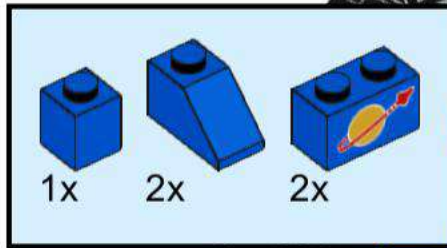

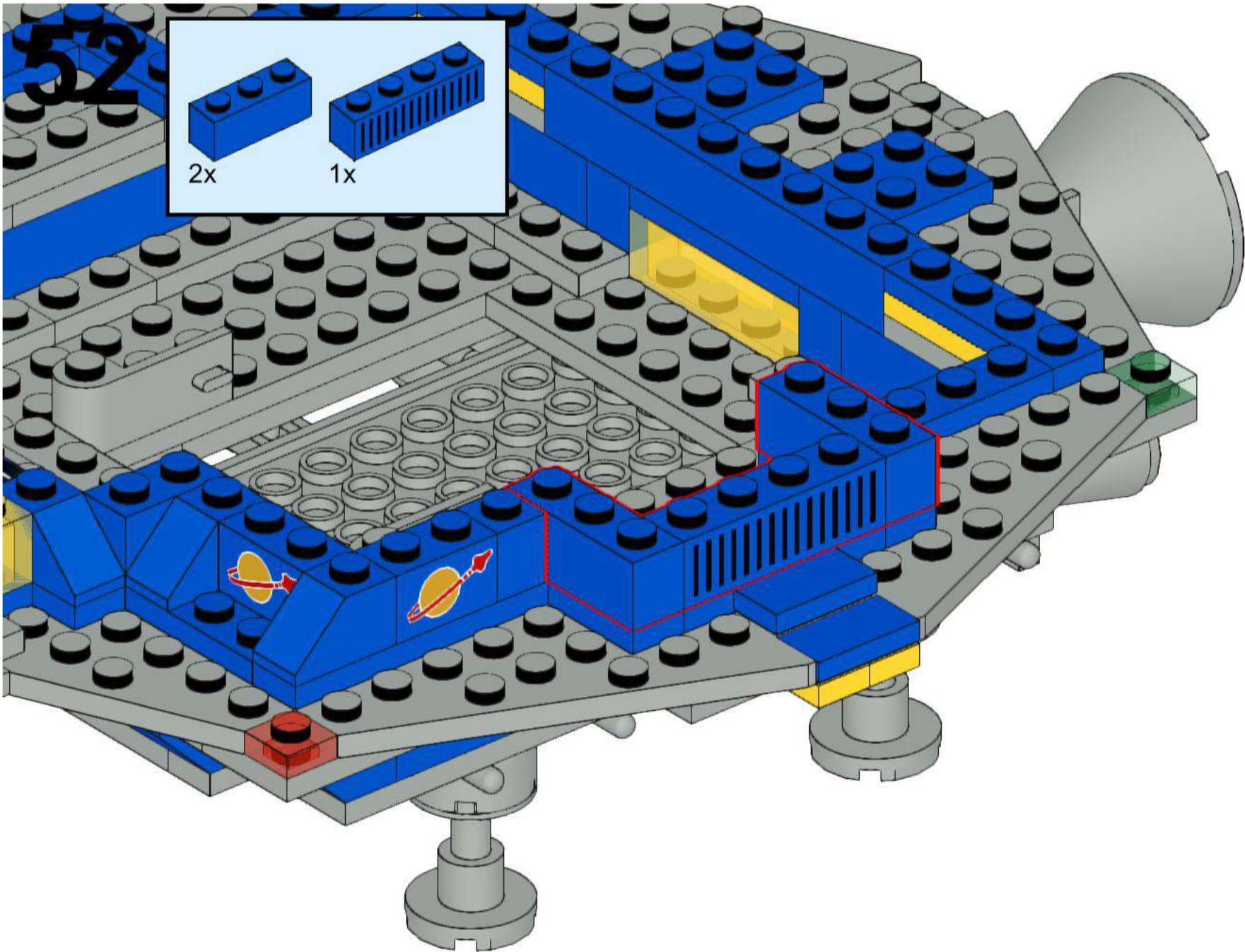

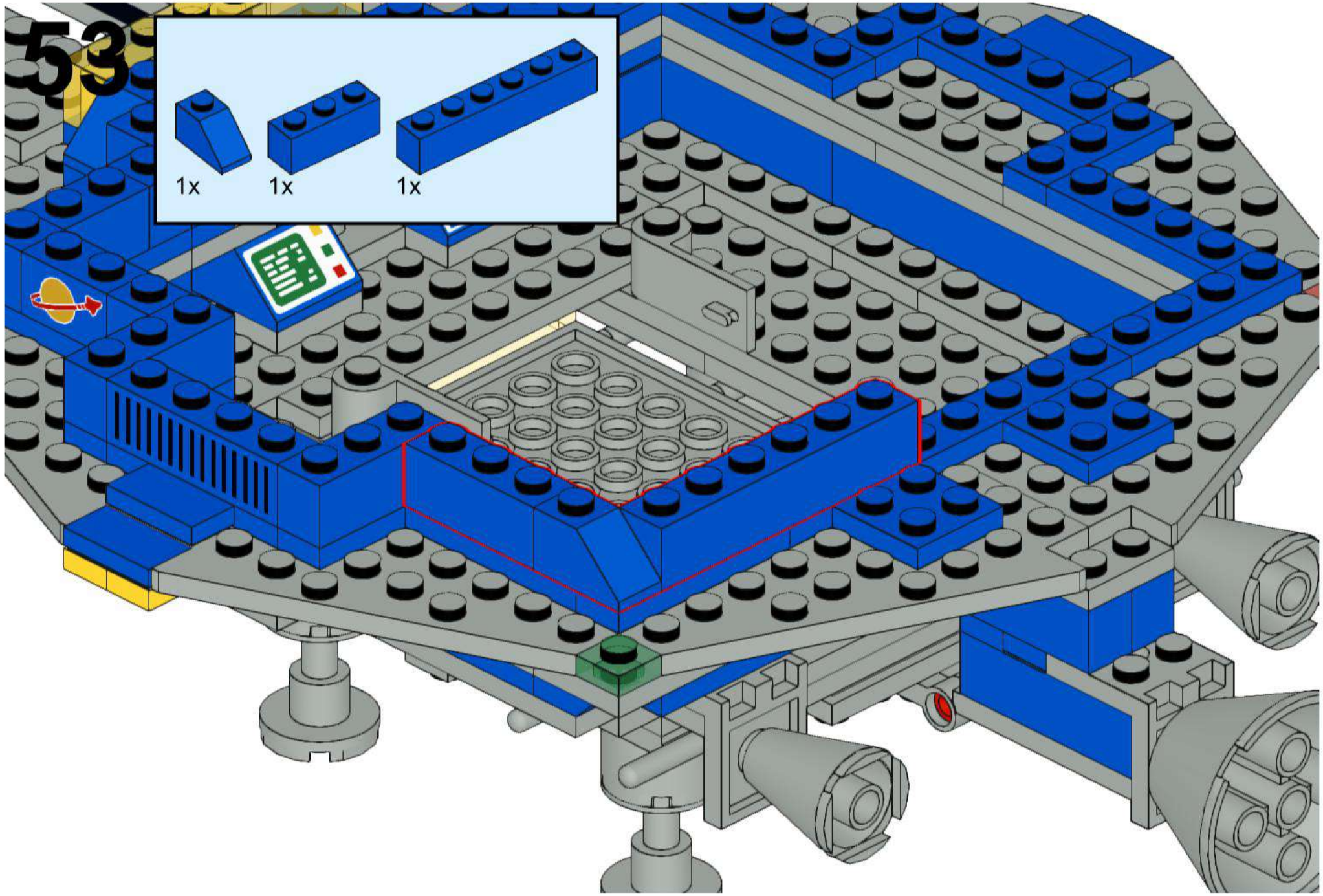

53

1x 1x 1x

An inset box with a light blue background showing three blue LEGO parts. From left to right: a 1x2 wedge, a 1x3 plate, and a 1x6 plate. Below each part is the text '1x'.

54

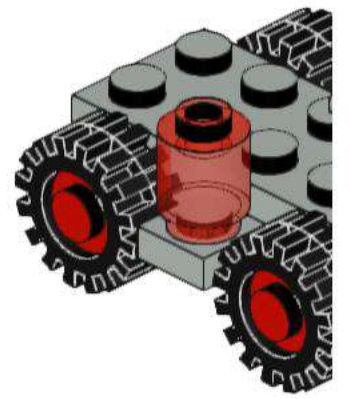
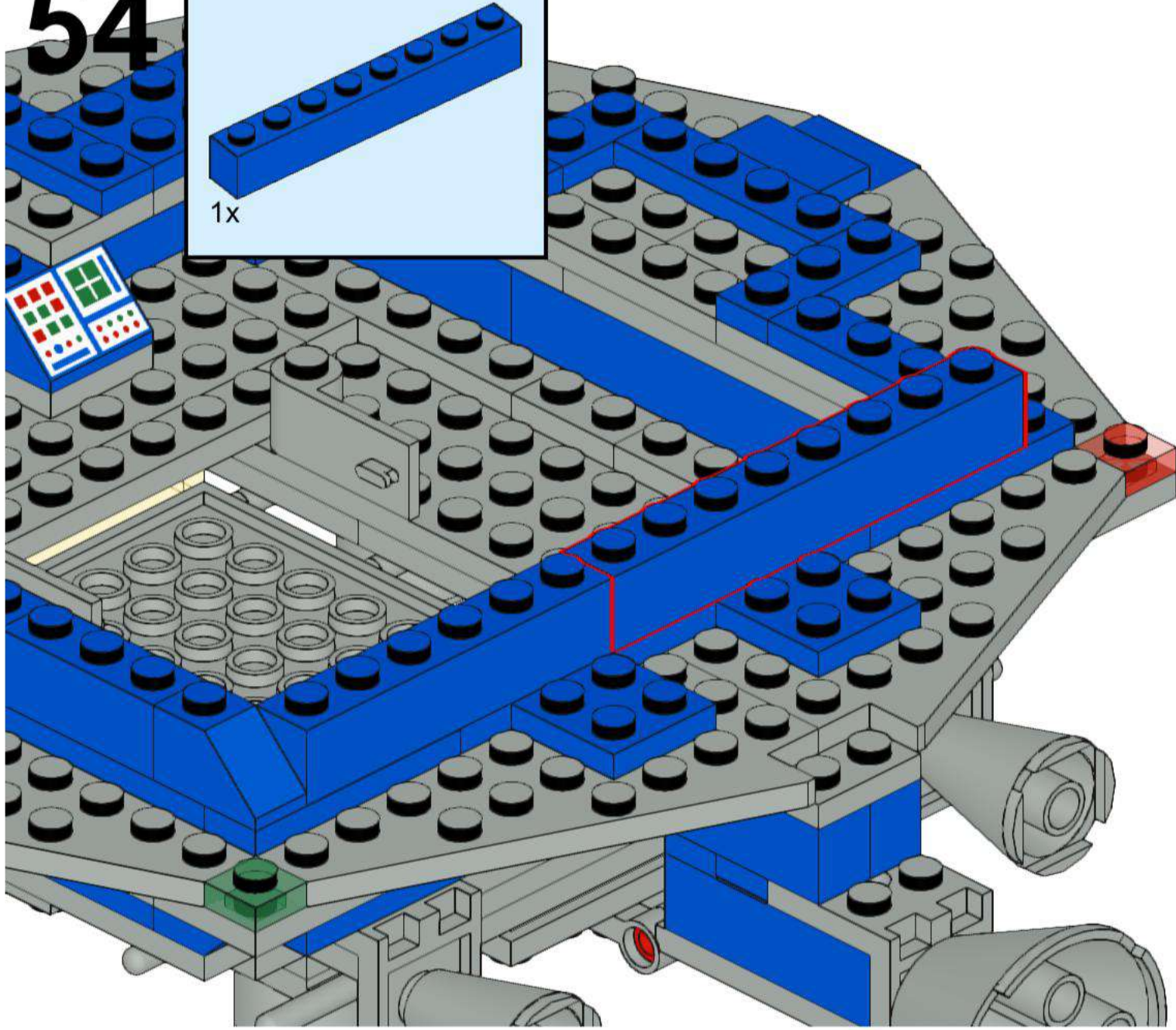
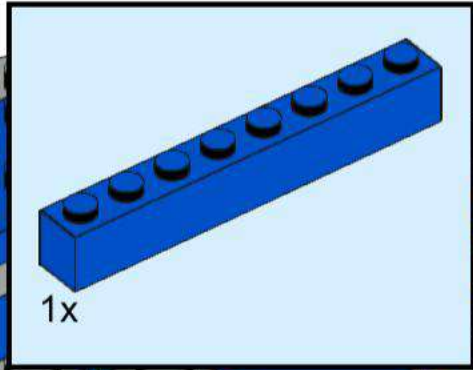

55

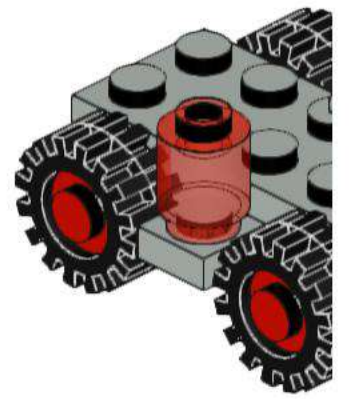
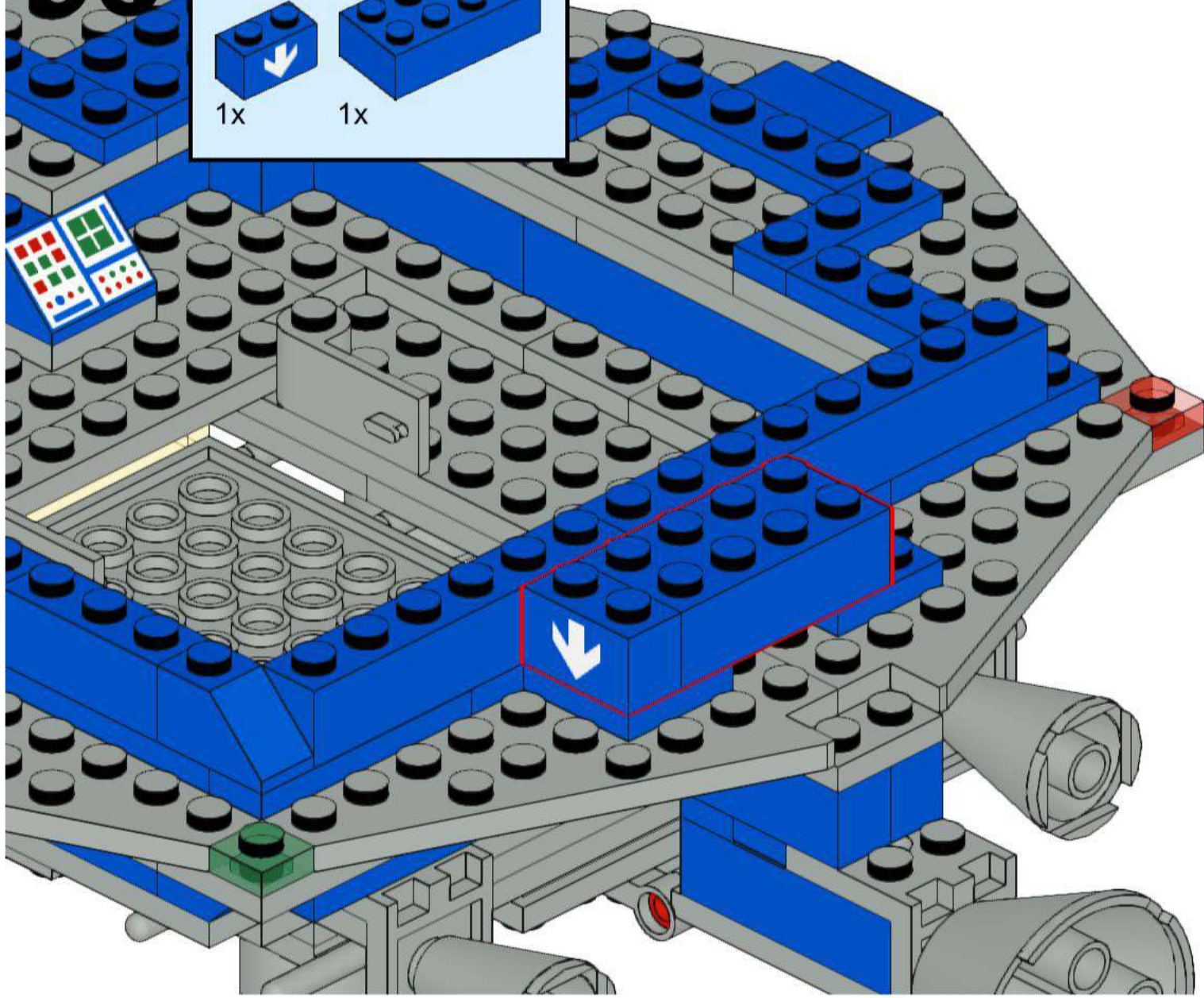
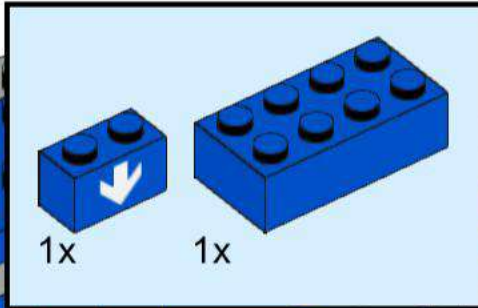

# 56

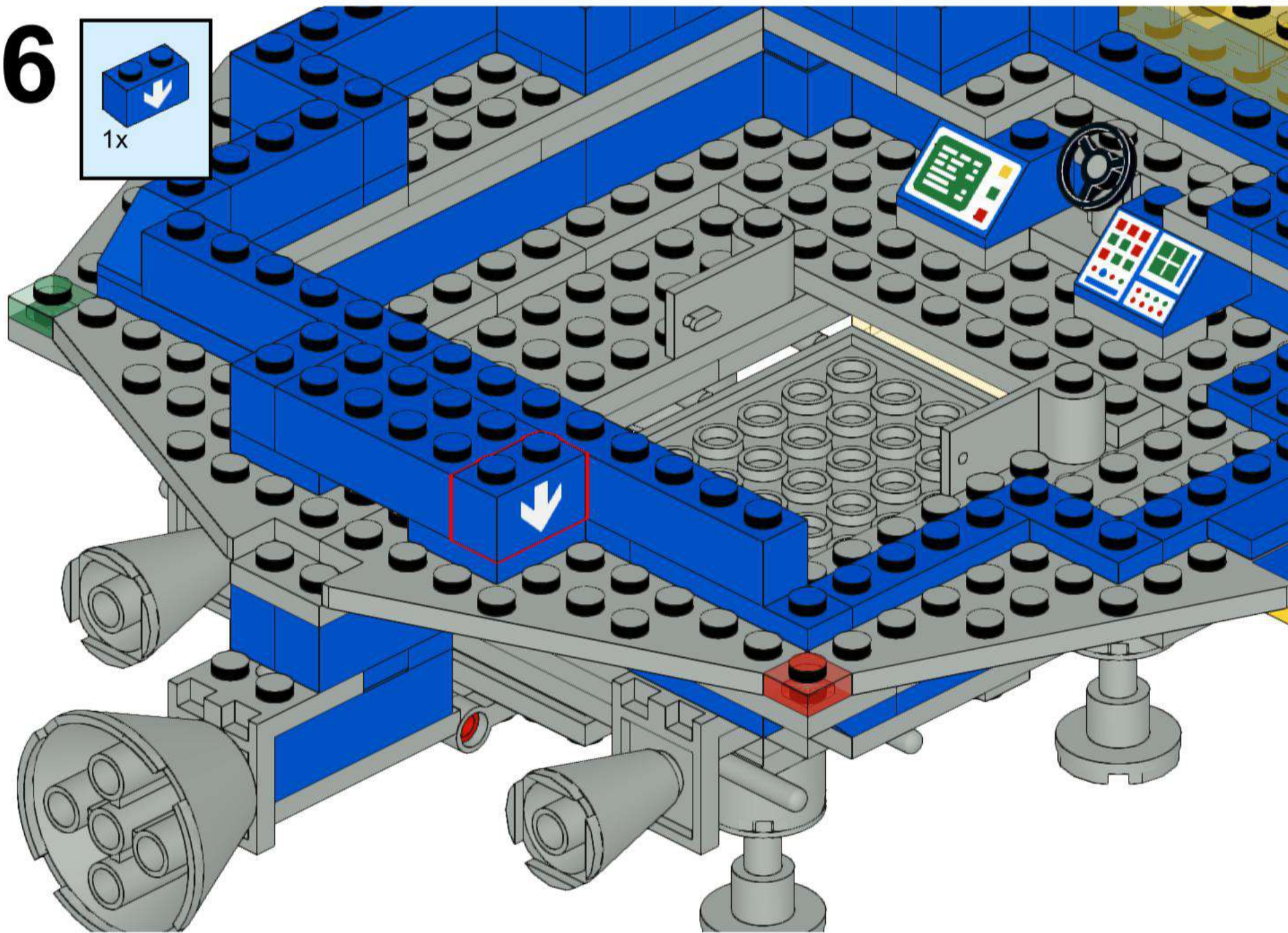
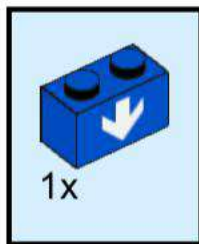



# 57

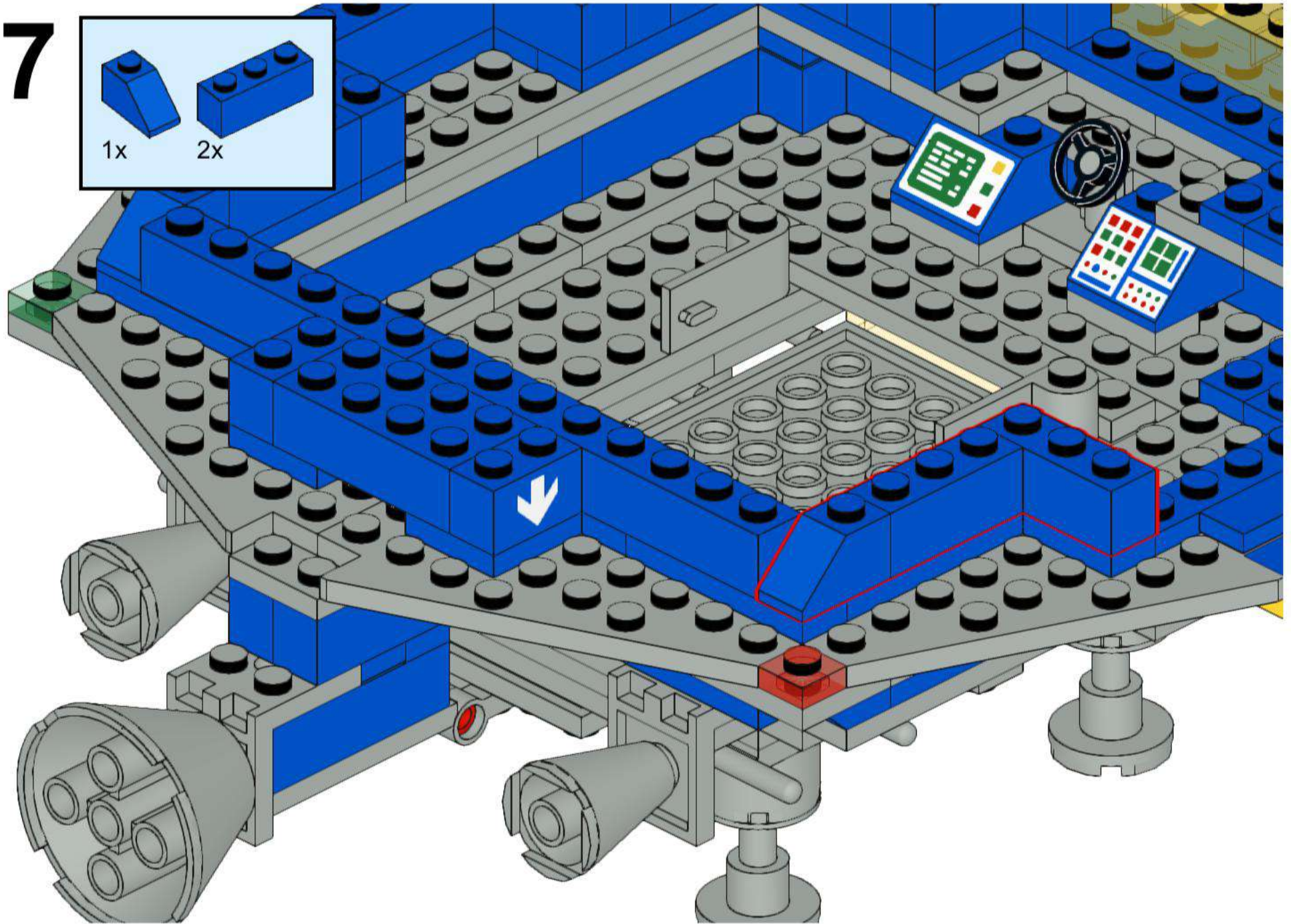
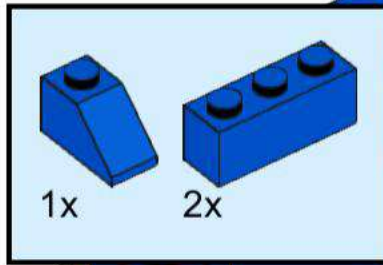

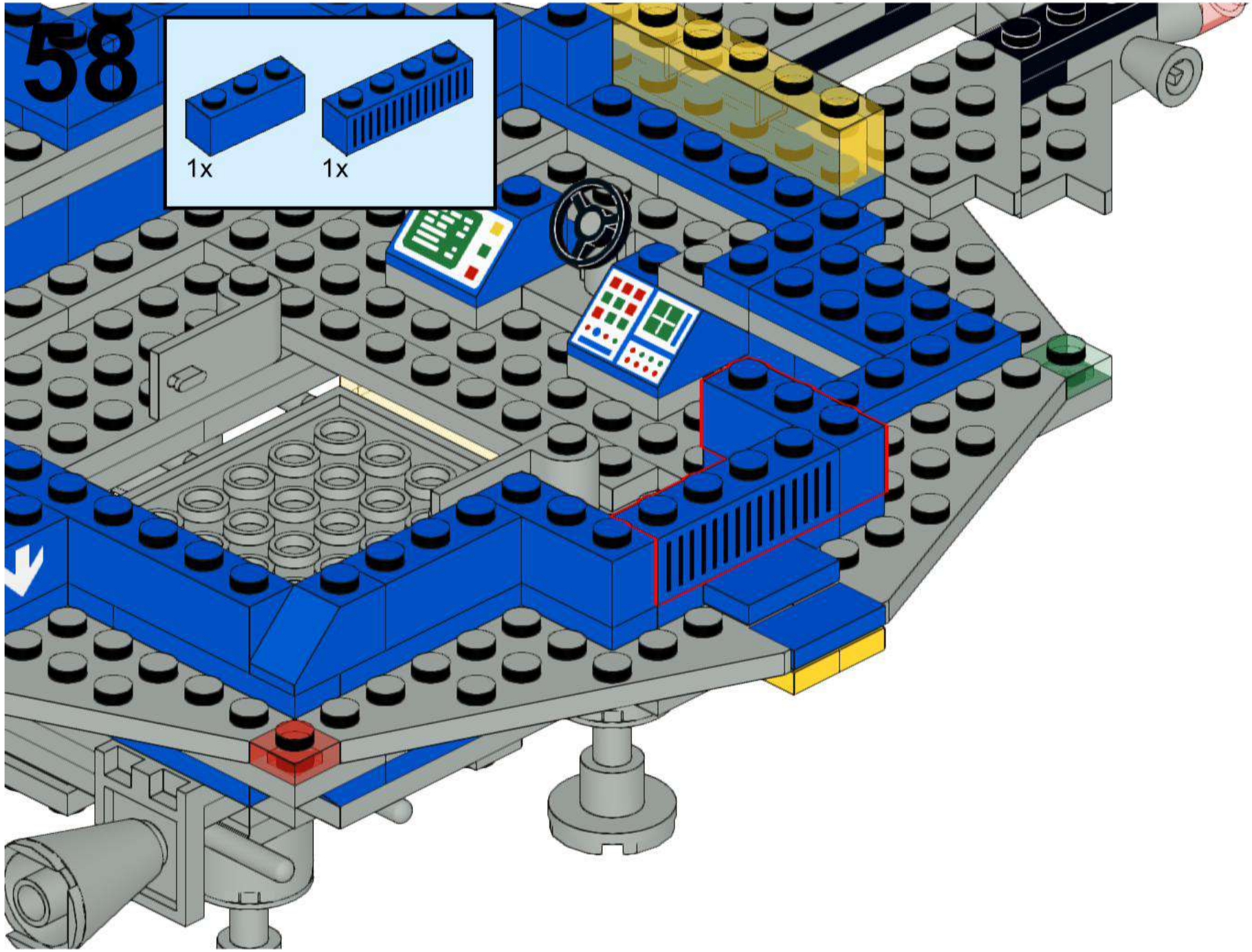

58

1x      1x



# 59

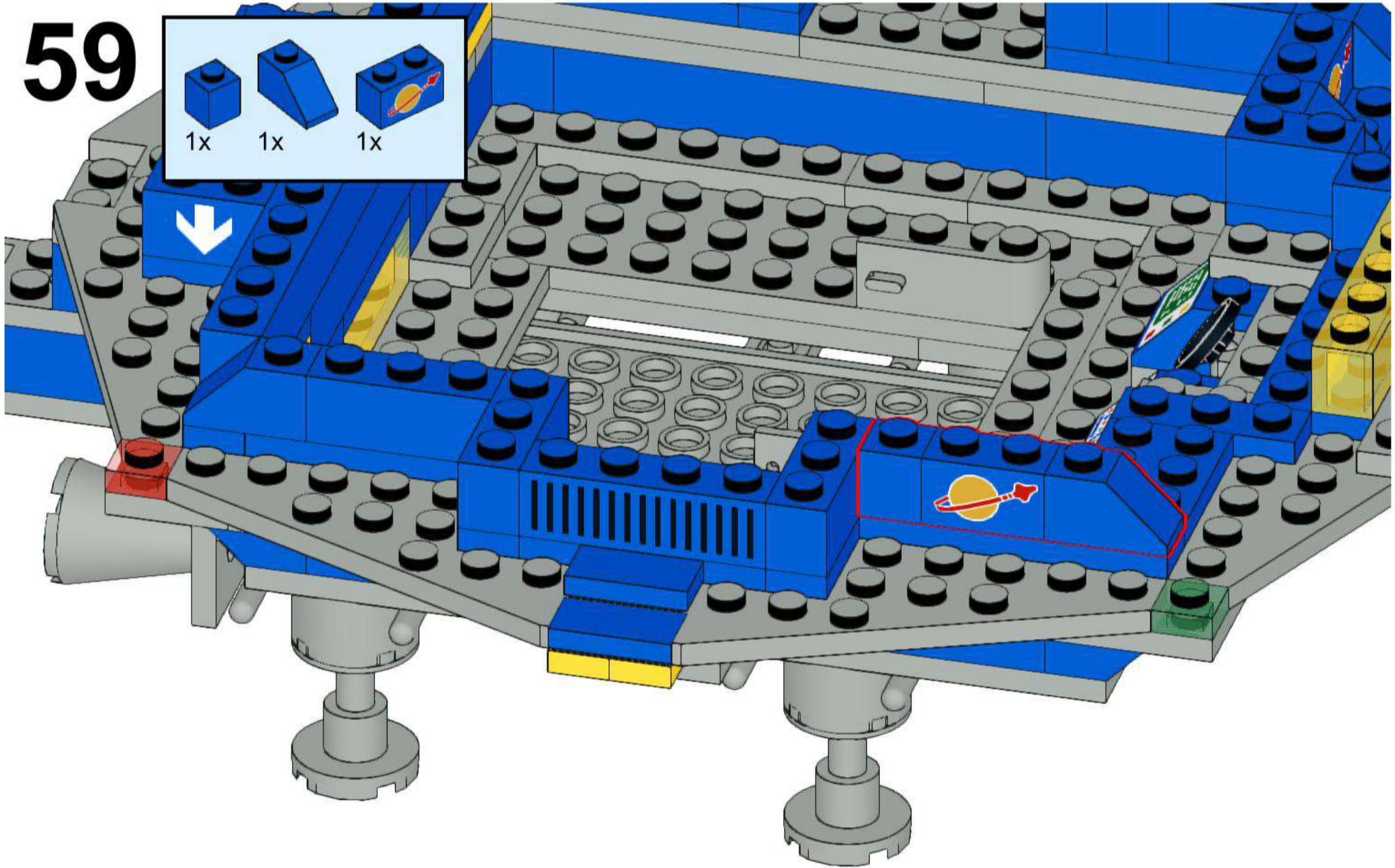
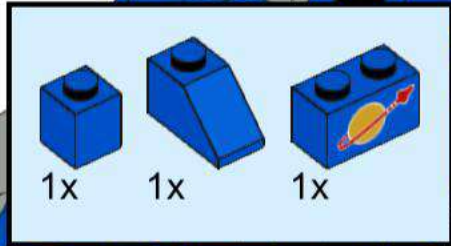

# 60

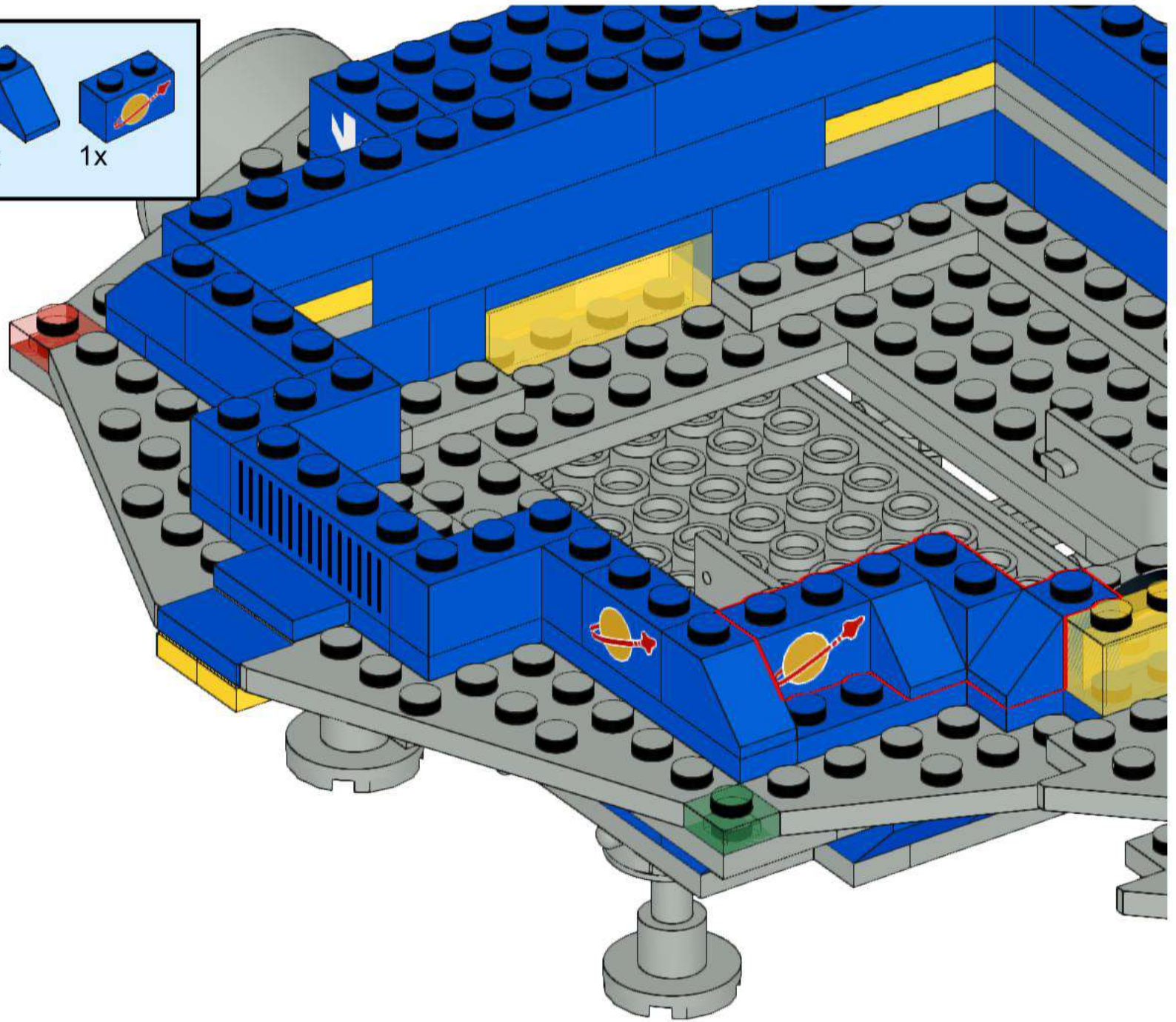
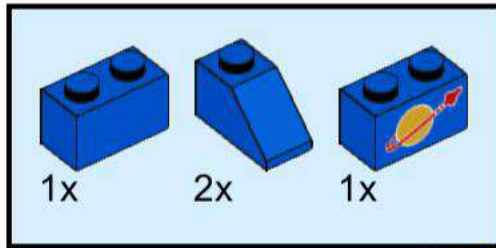



# 62

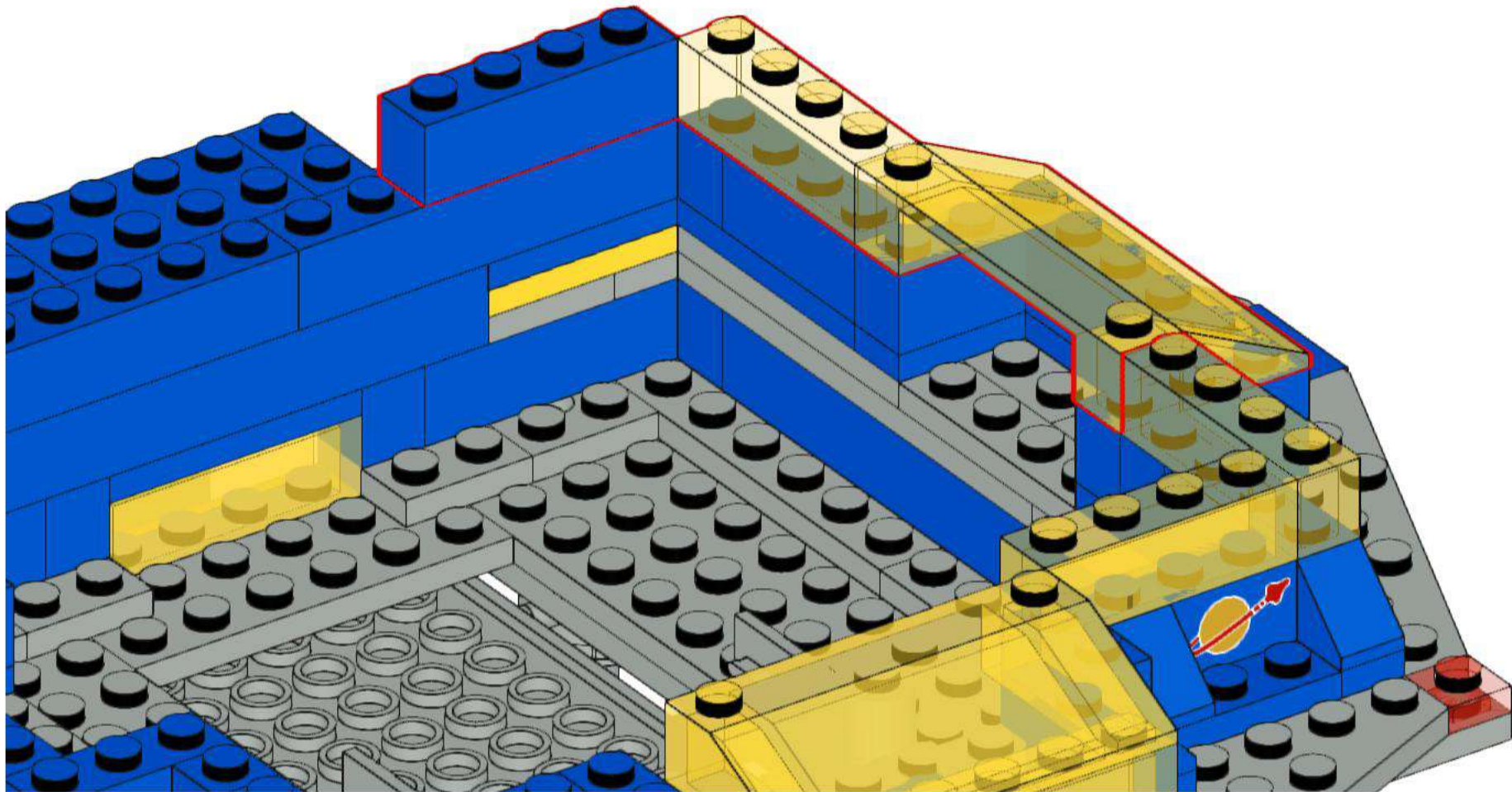
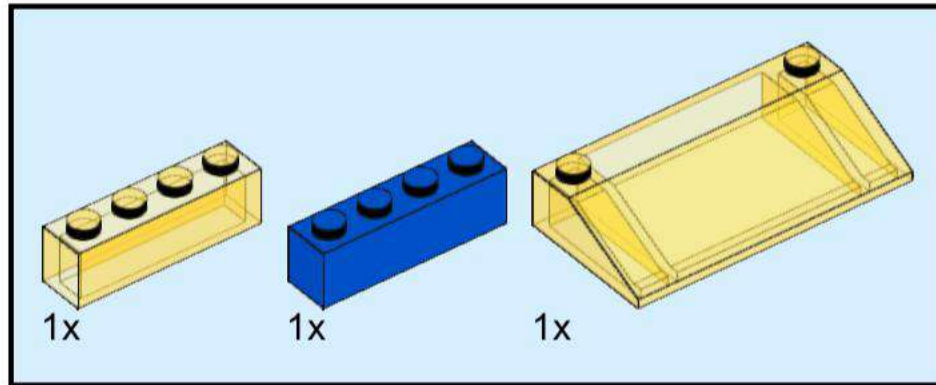

63

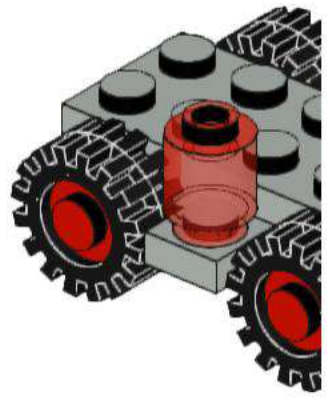
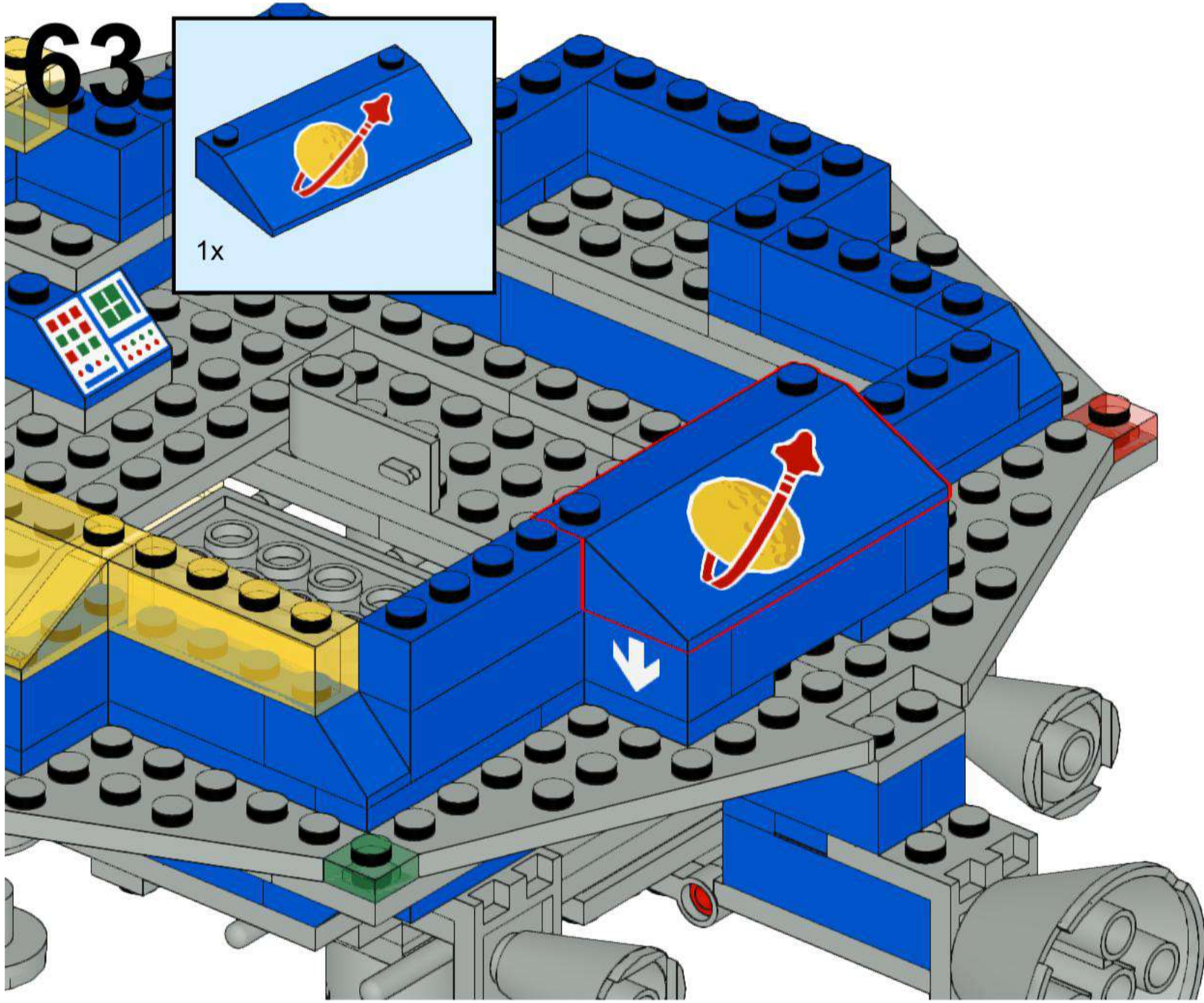
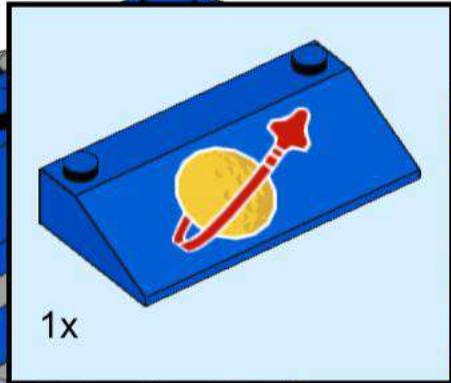

64

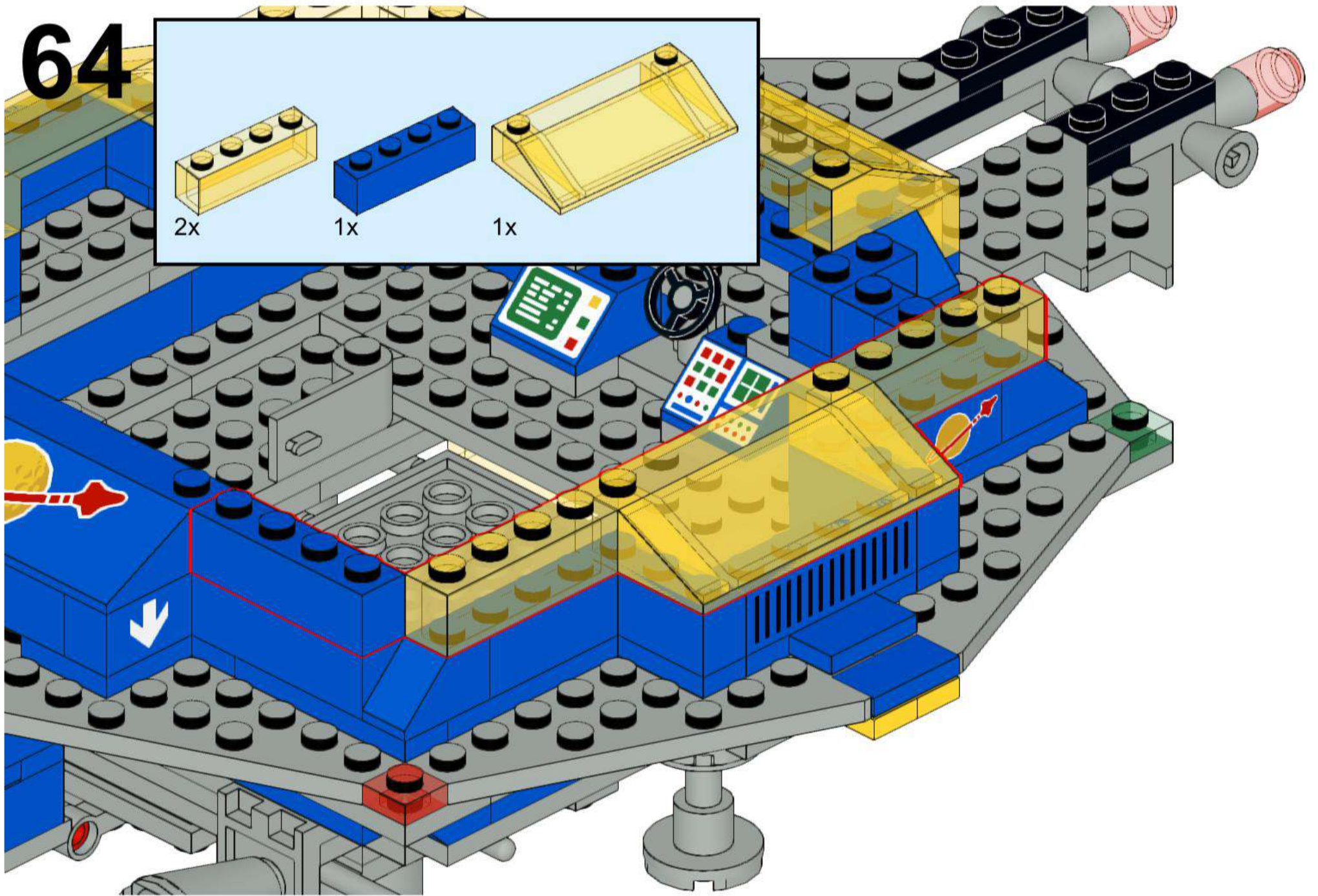
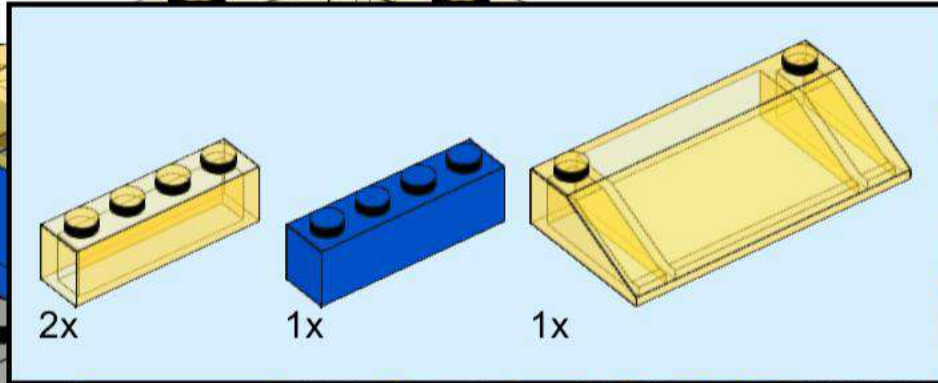



# 65

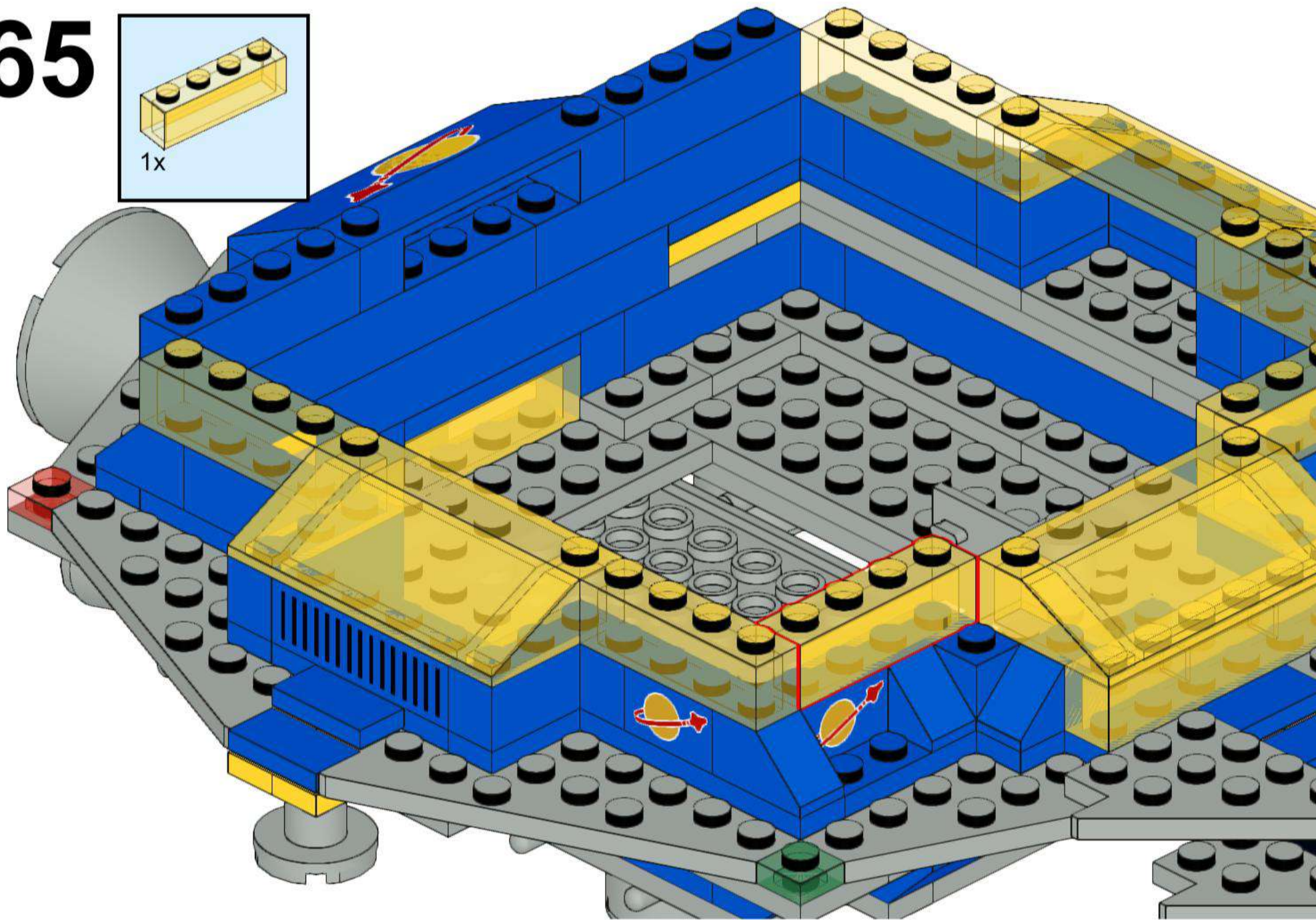
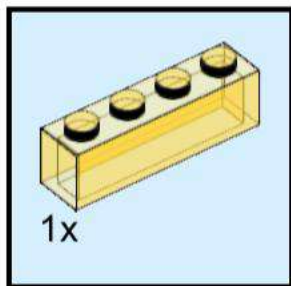

# 66

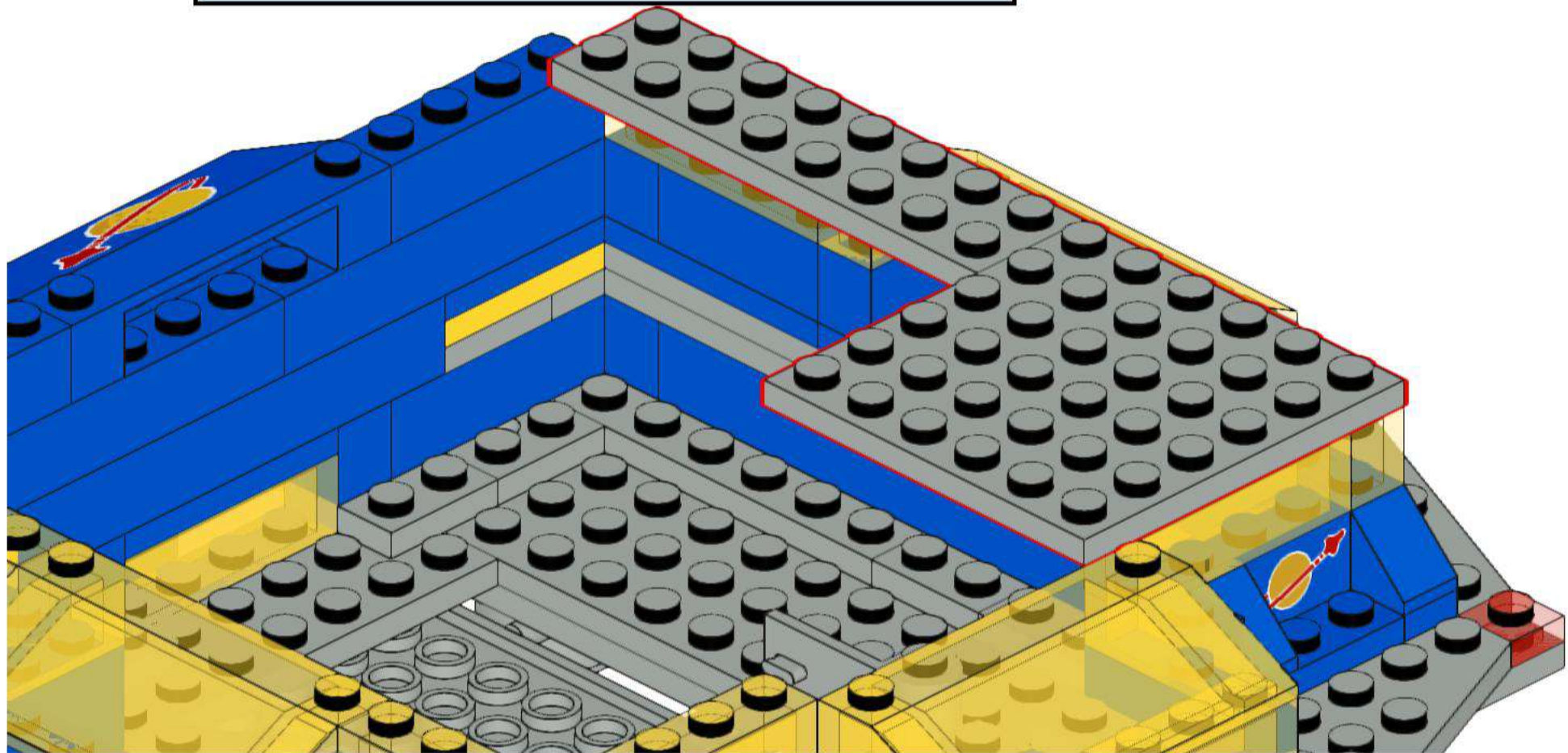
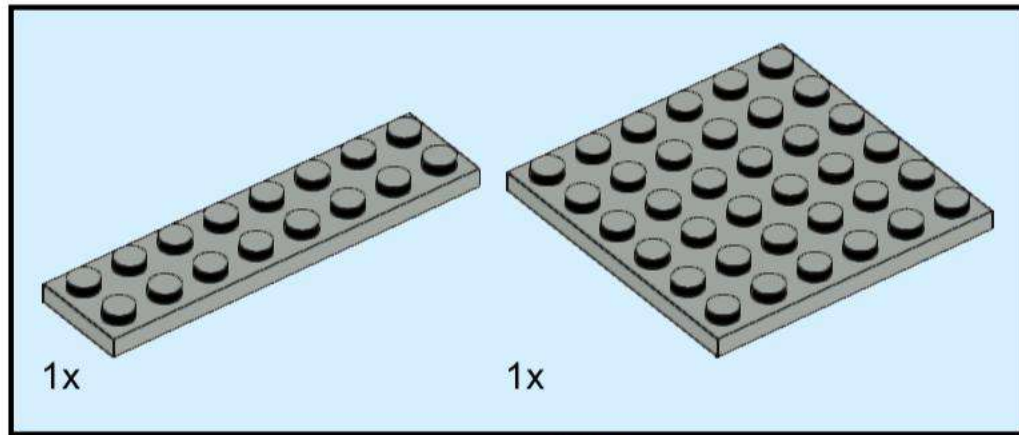

# 67

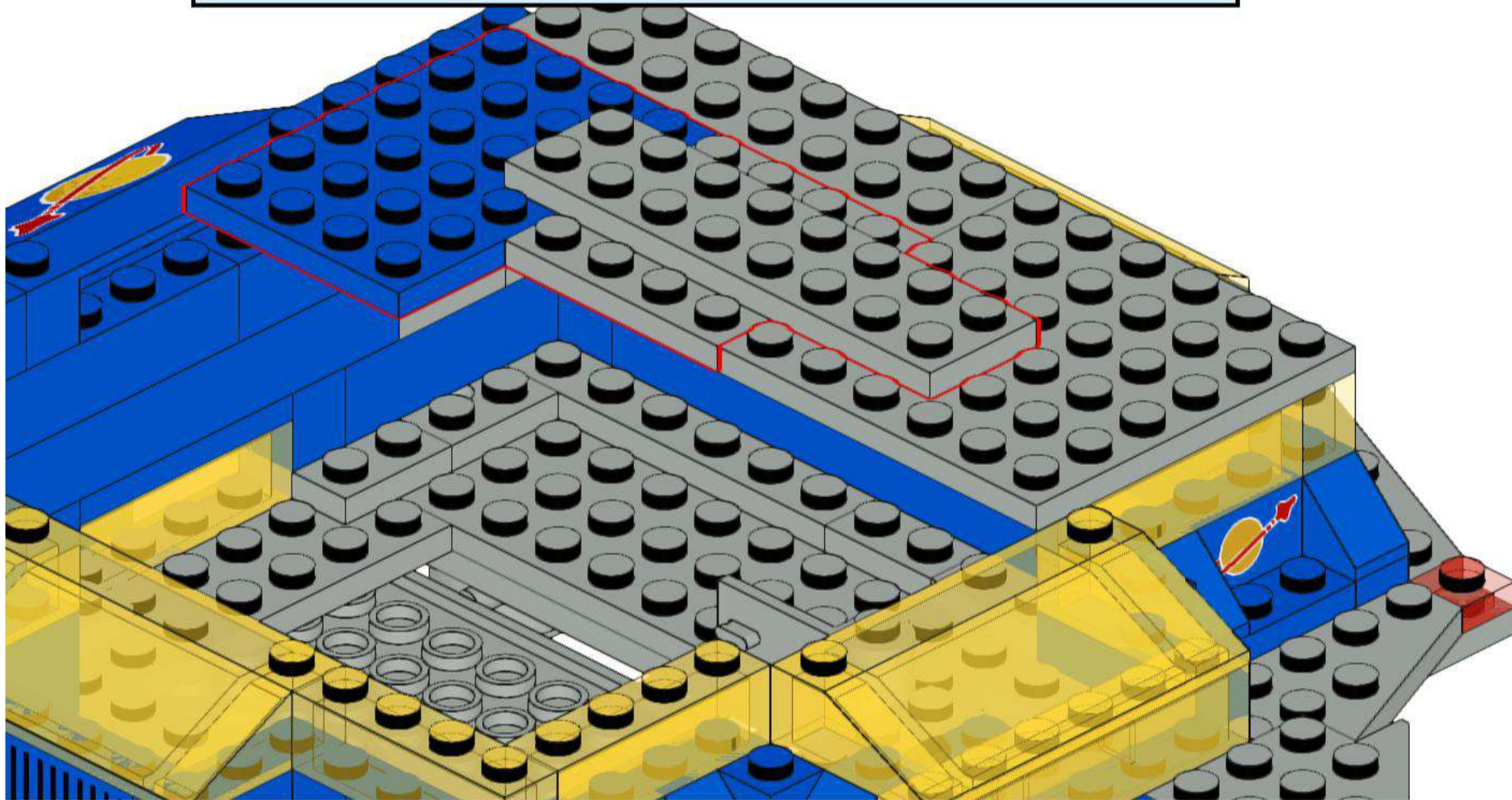
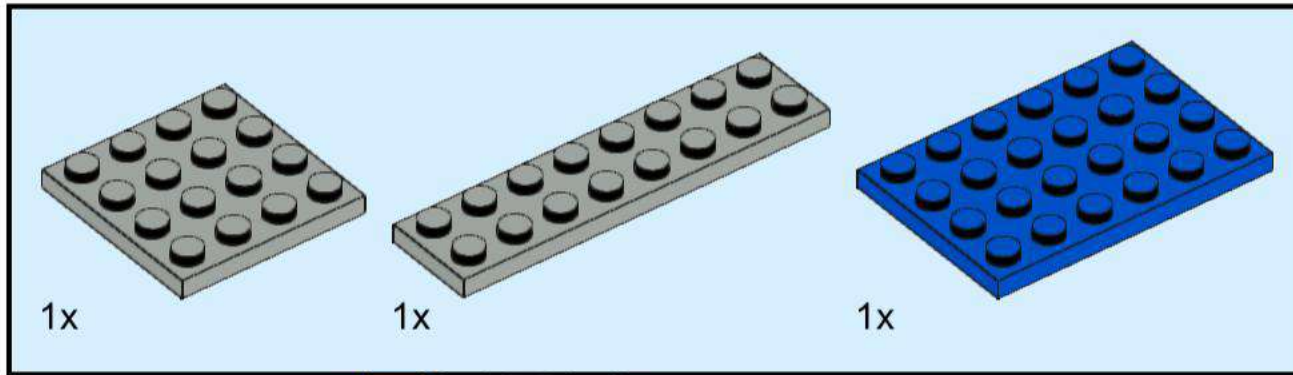

# 68

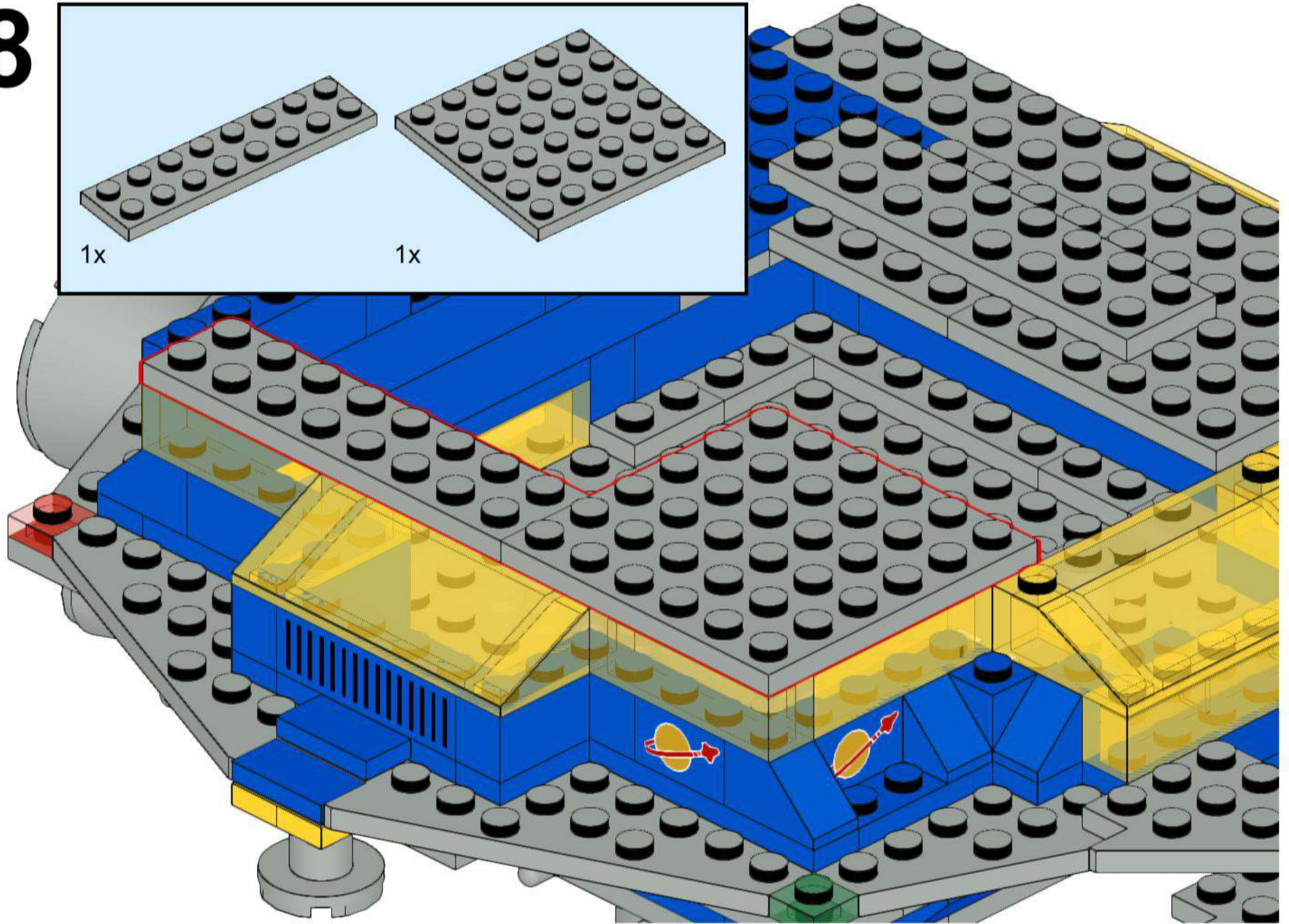
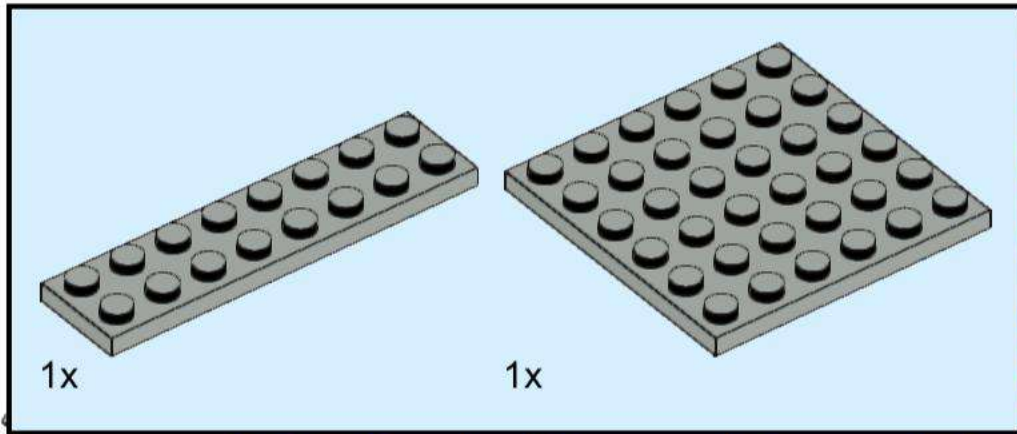

# 69

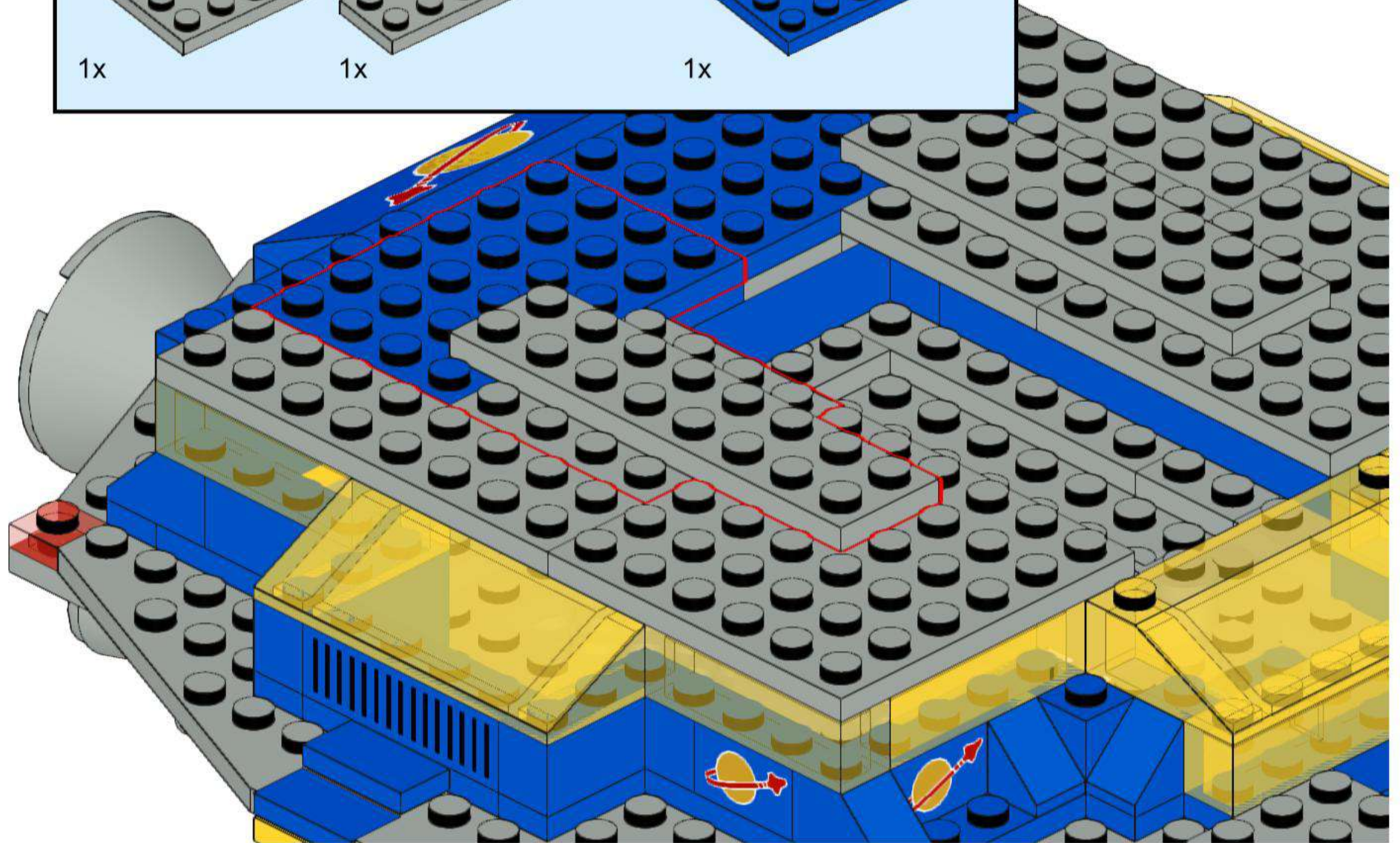
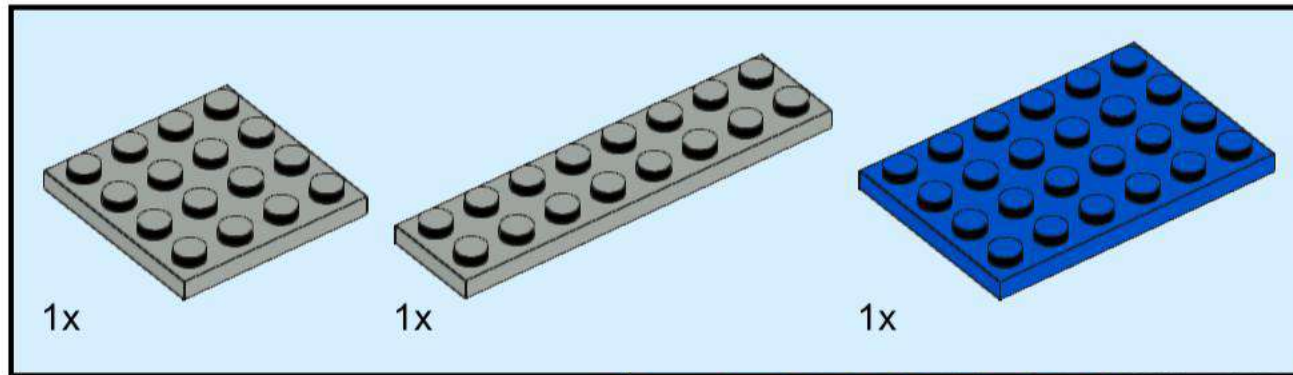

# 70

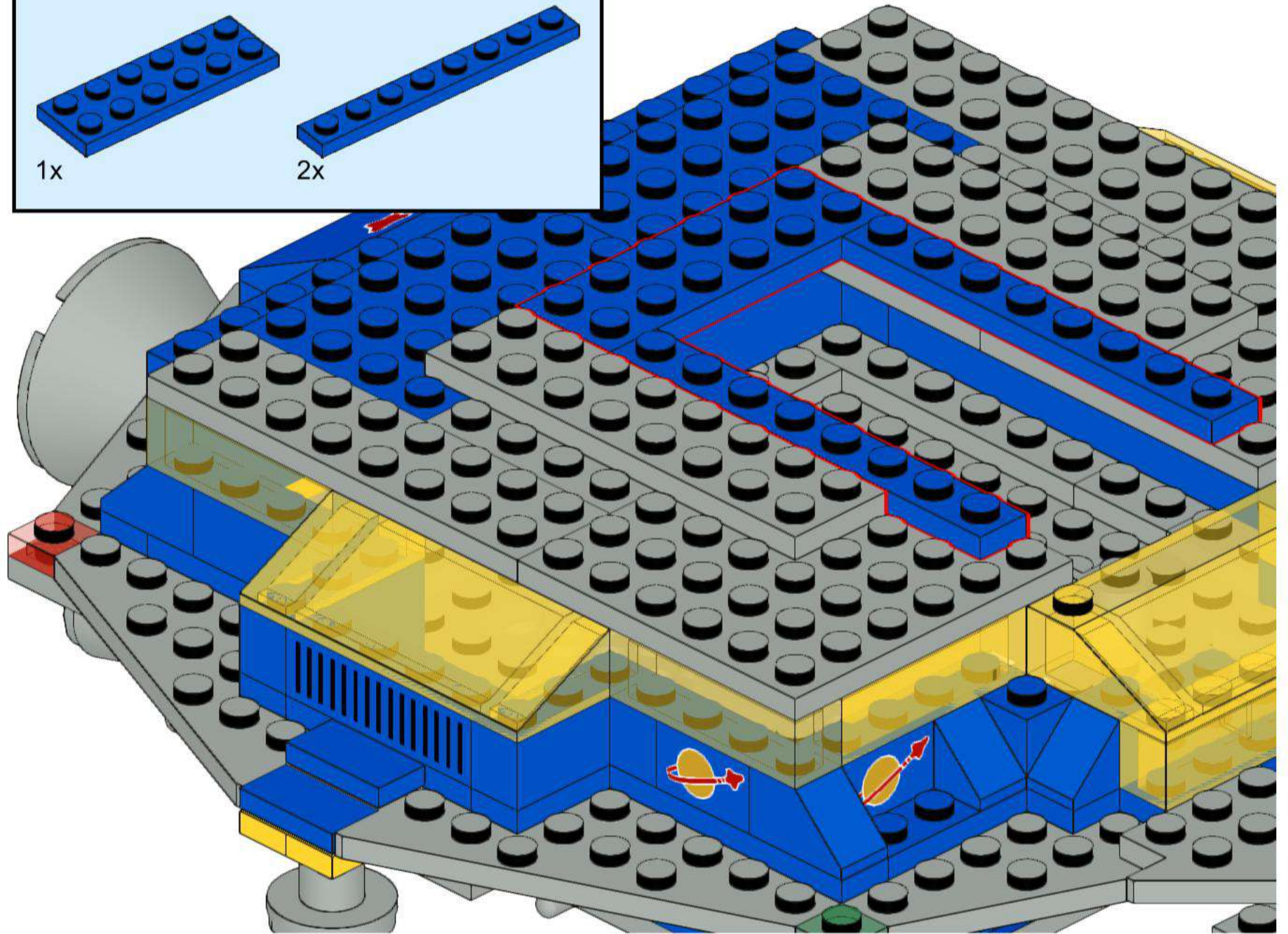
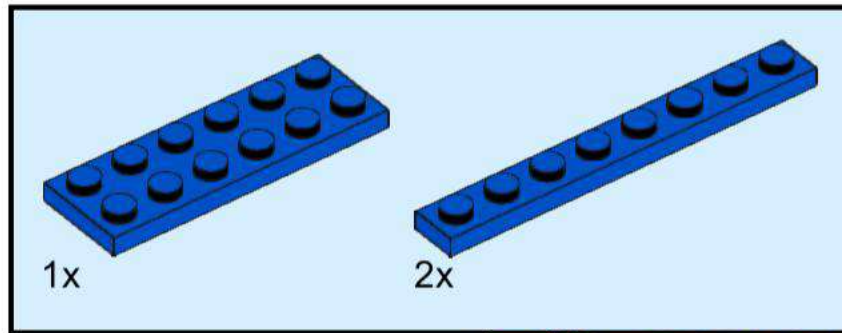

# 71

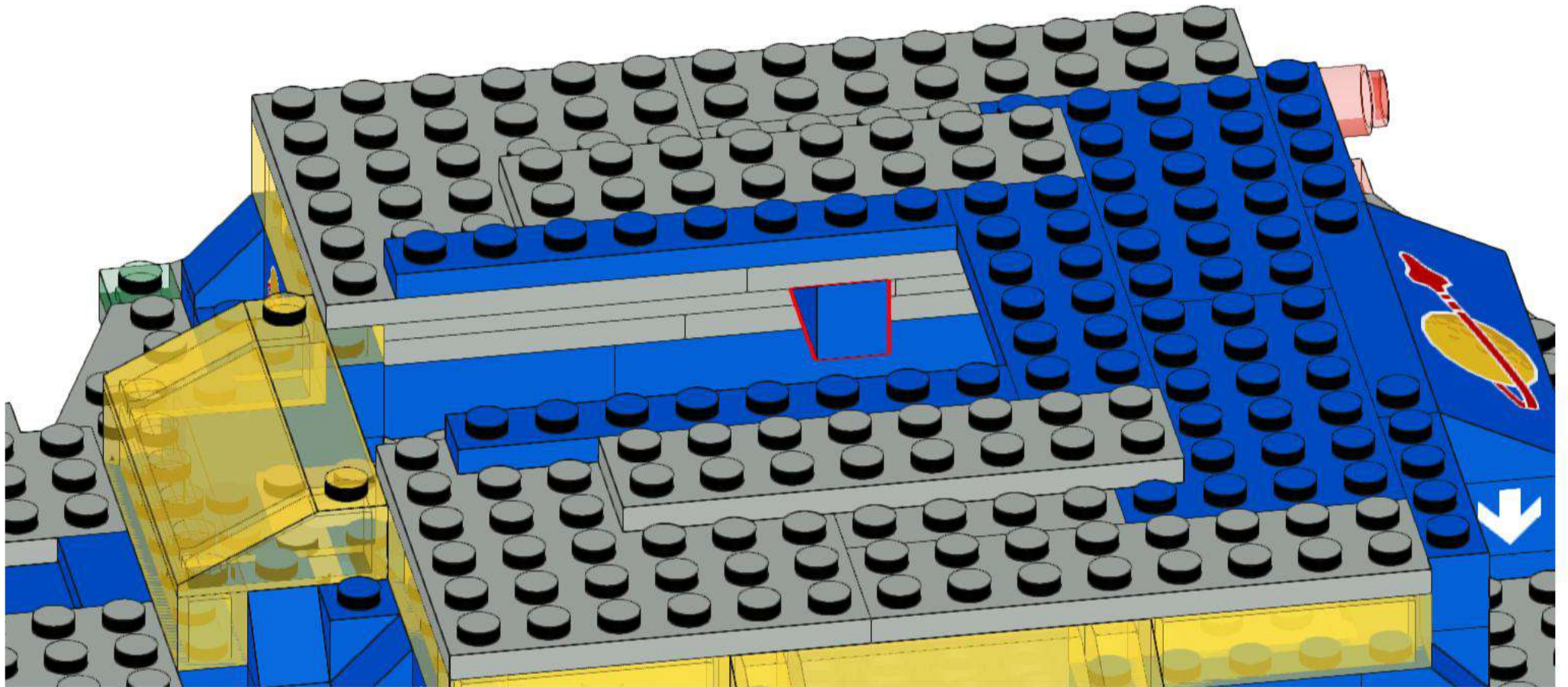
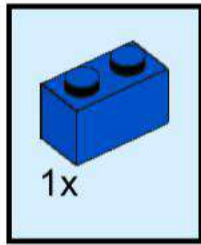

# 72

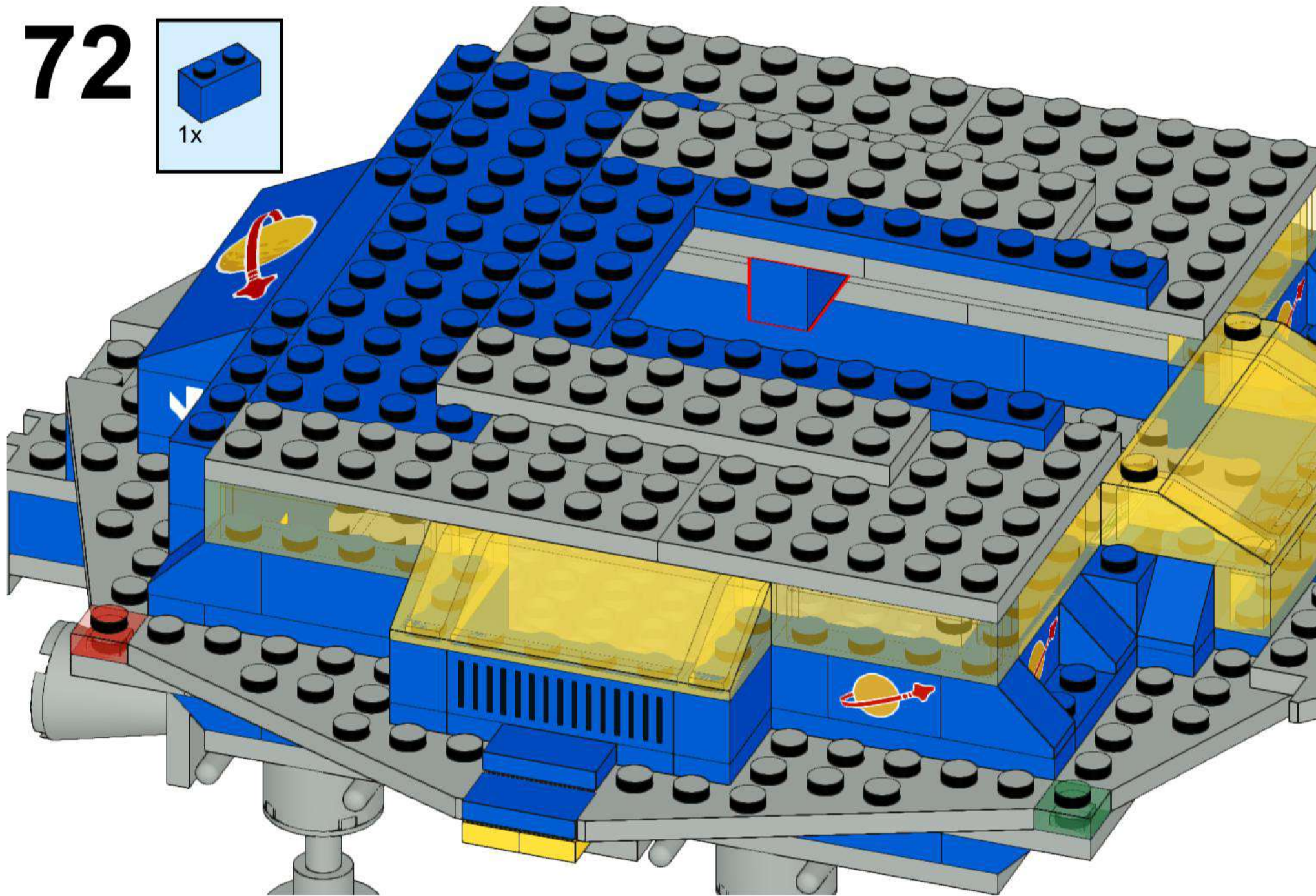
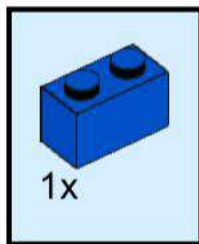





# 74

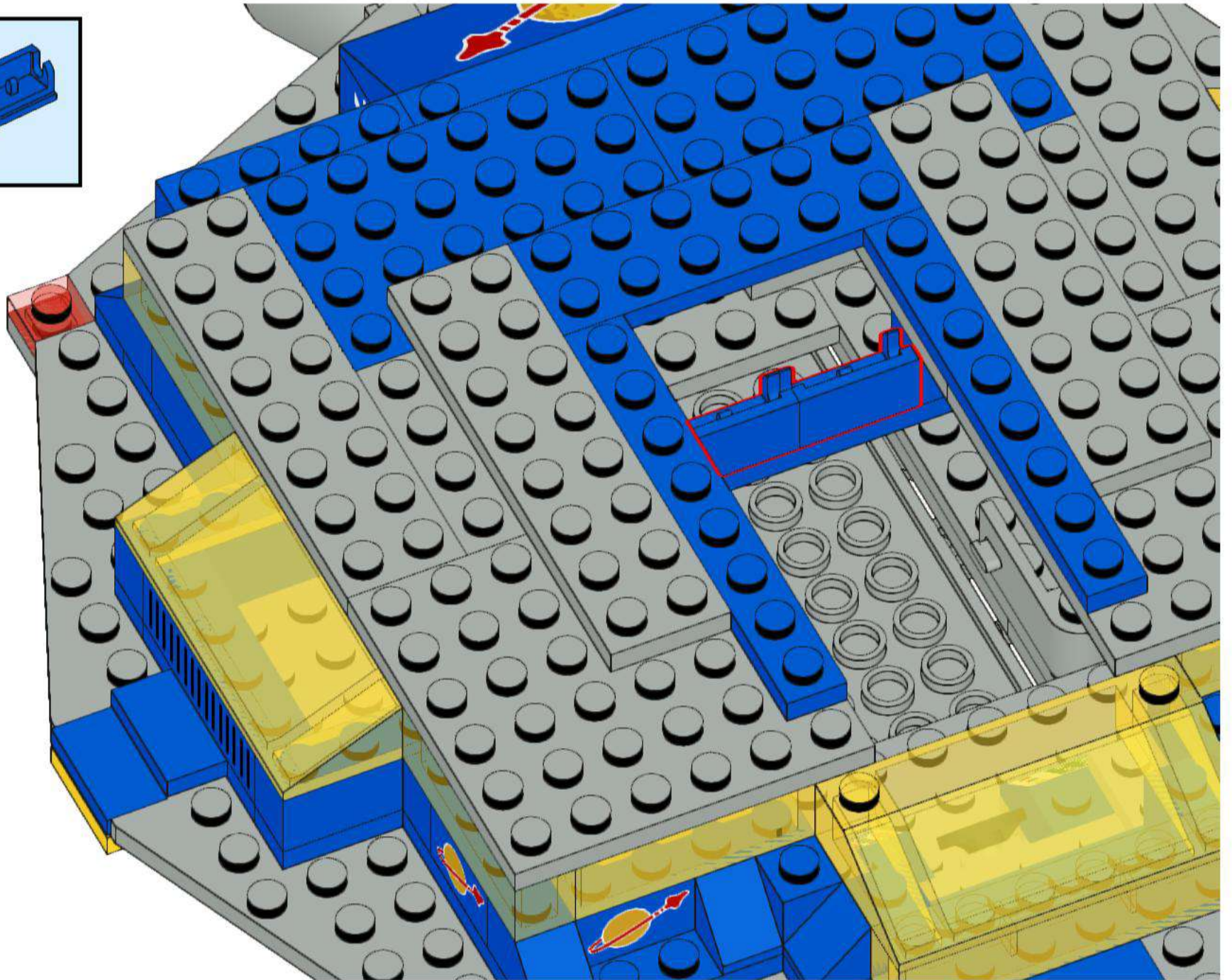
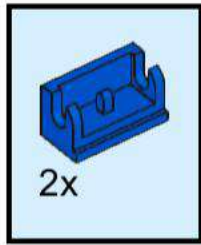

# 75

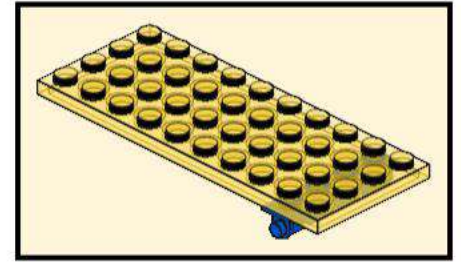
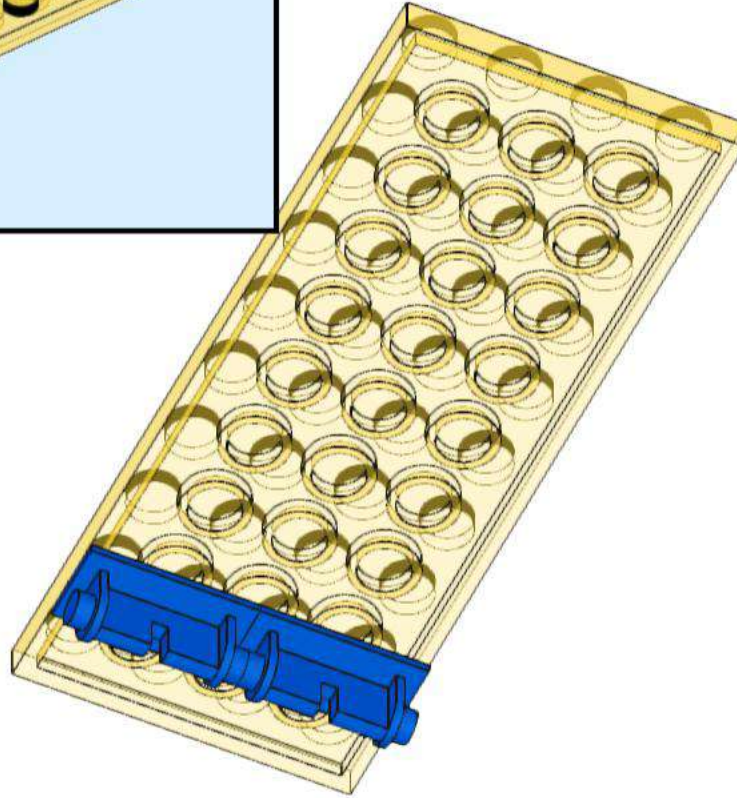
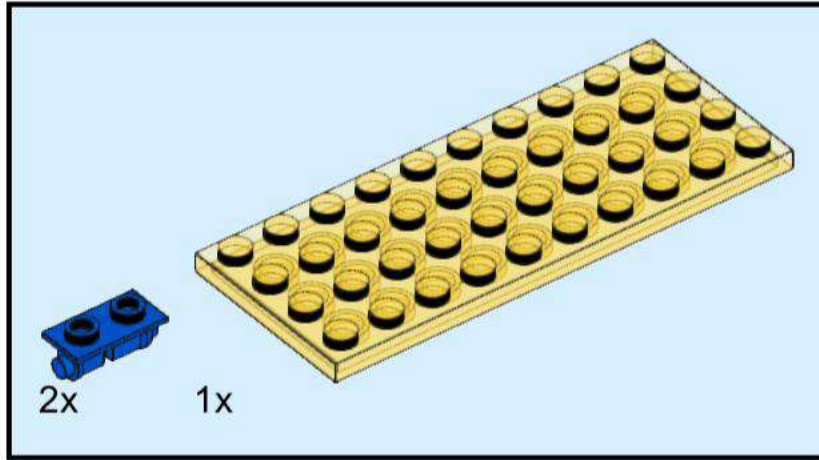

76

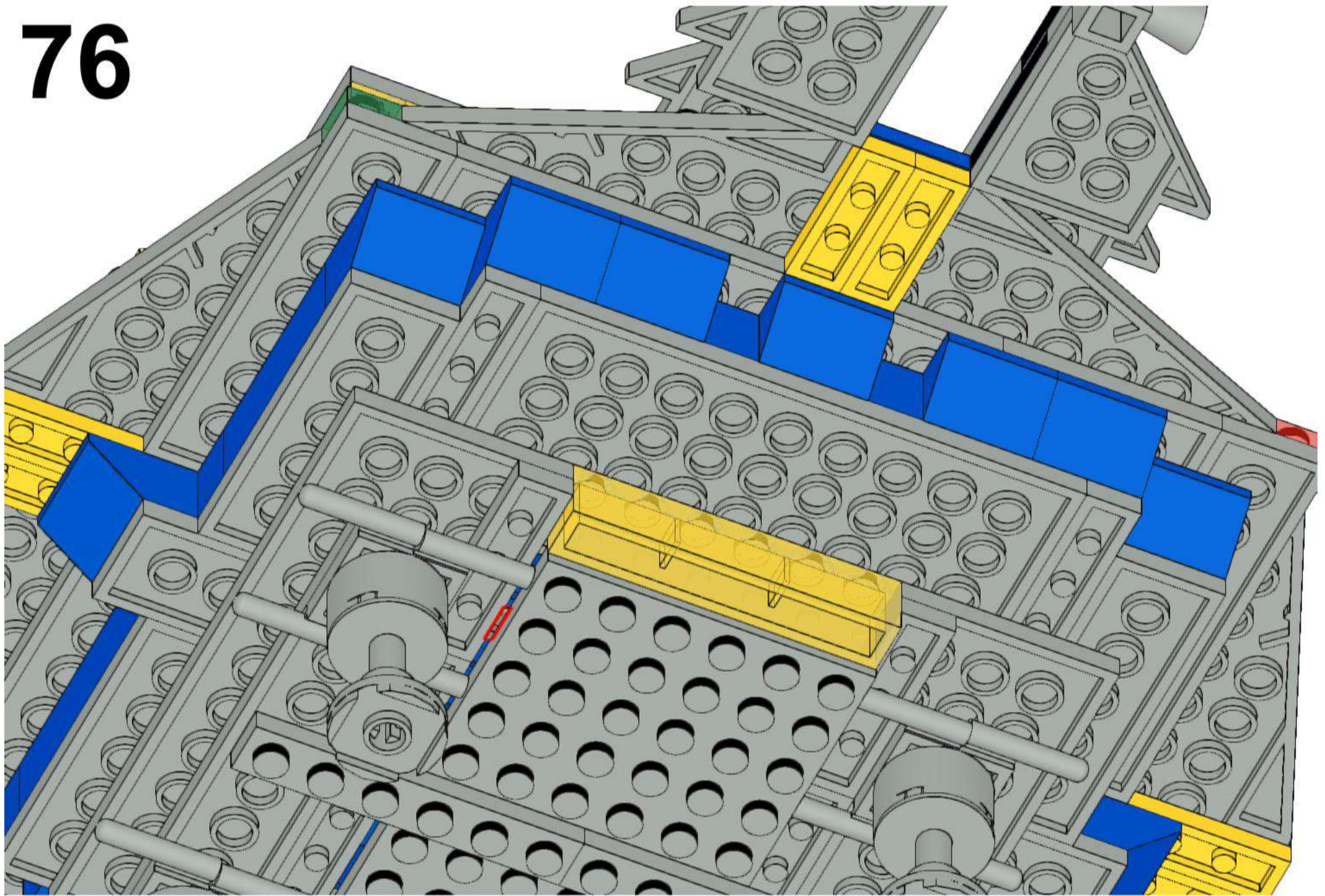

# 77

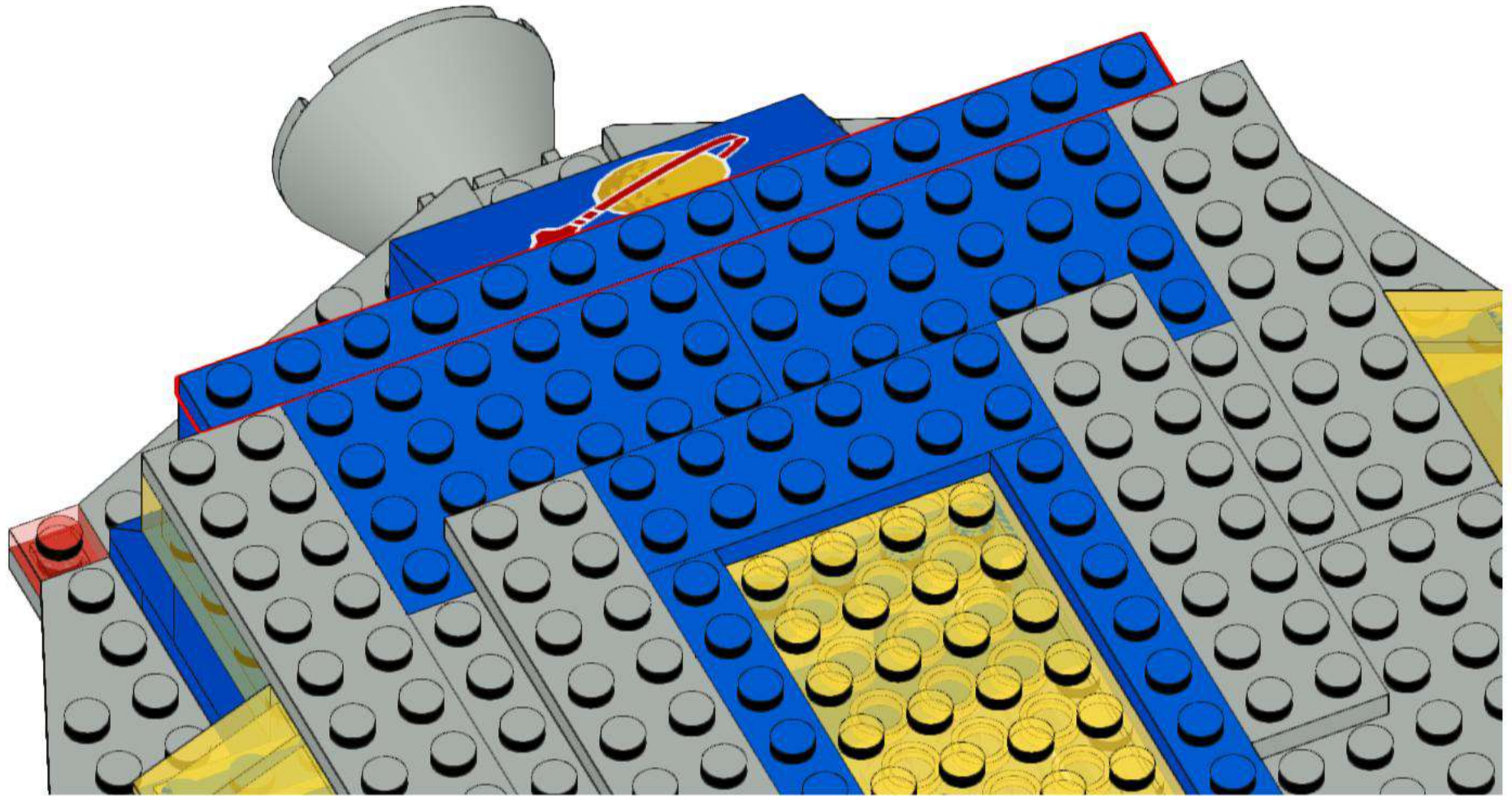
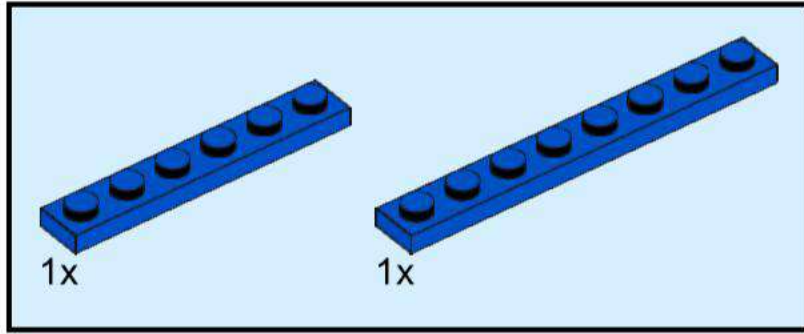

# 78

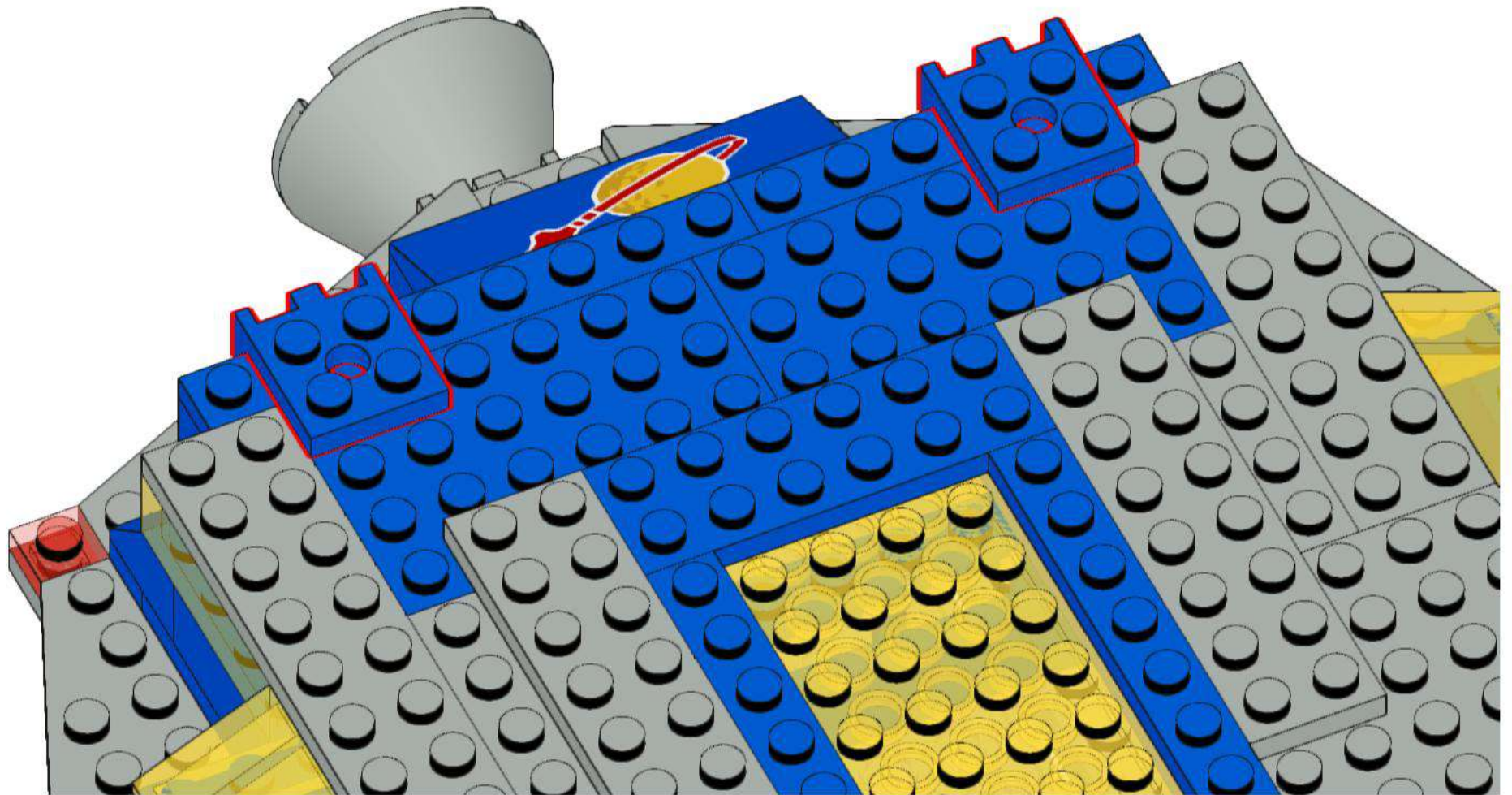
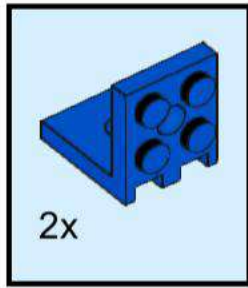



# 80

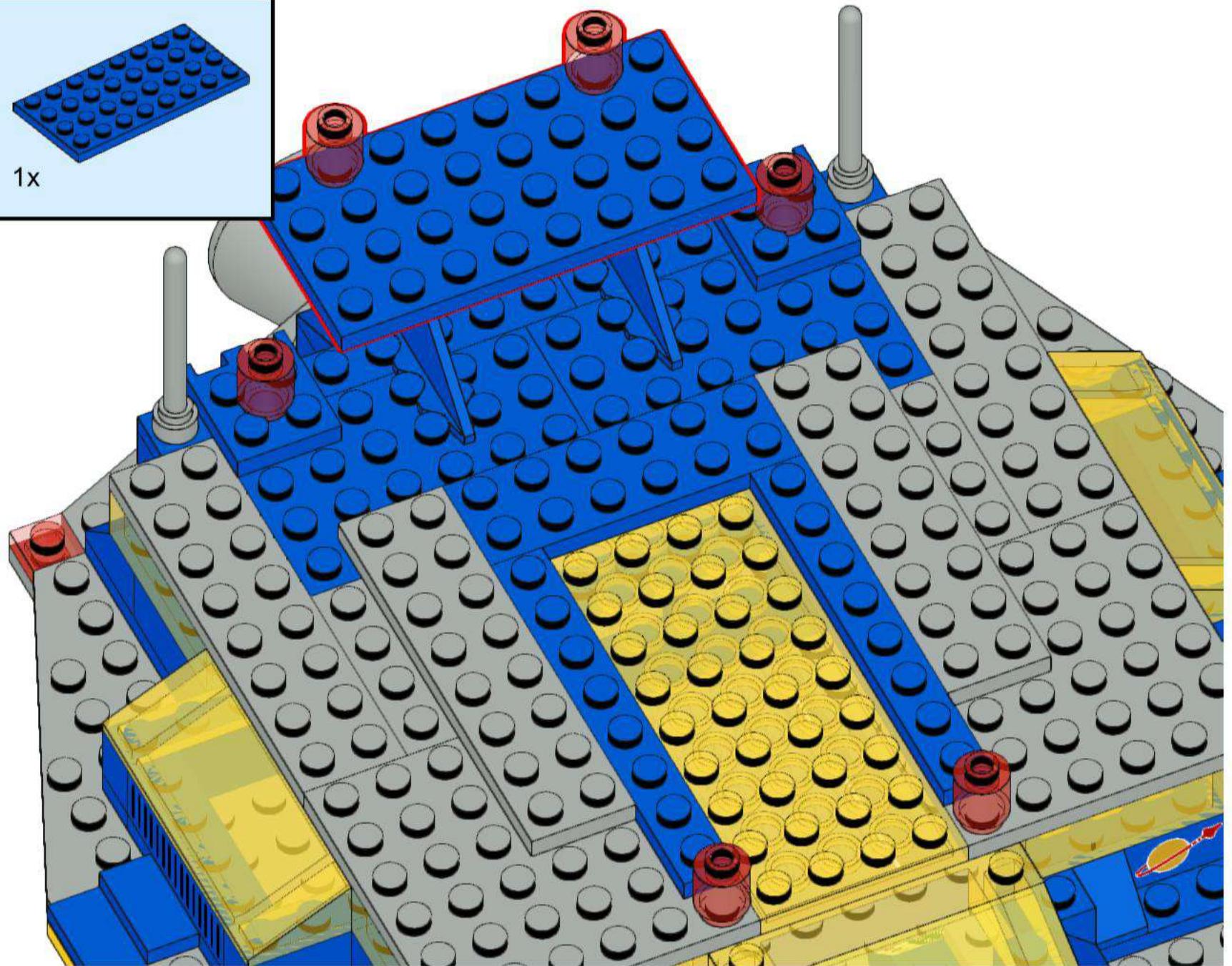
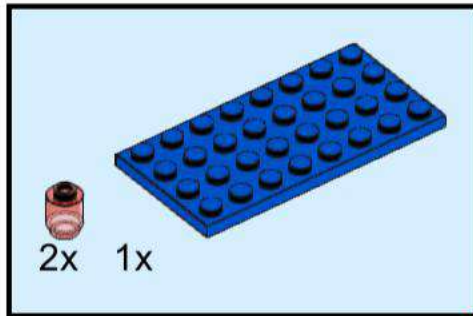



81

